

## OP series display

### Catalog

#### **Chapter 1 Summary of the products.....3**

1-1	Function .....	3
1-2	General specification.....	5
1-3	Product types.....	6
1-4	Each part's name .....	7
1-4-1	OP320/OP320-S .....	7
1-4-2	OP320-A/OP320-A-S .....	10
1-5	Interface definition and connection graph.....	16
1-5-1	OP320 .....	16
1-5-2	OP320-S.....	17
1-5-3	OP320-A .....	18
1-5-4	OP320-A-S .....	19
1-6	Sizes and installing methods .....	21

#### **Chapter 2 Editor Software OP20.....23**

2-1	Basic summary of OP20 .....	23
2-1-1	About the project and the screen.....	23
2-1-2	The content of screen.....	23
2-1-3	The use flow of OP20 .....	24
2-2	Edit the user's screen .....	25
2-2-1	Create a project .....	25
2-2-2	Make a basic screen .....	27
2-2-3	The system parameter of OP20.....	28
2-2-4	Text .....	30
2-2-5	Function key (screen jump) .....	32
2-2-6	Data display window .....	36
2-2-7	Data set window .....	40
2-2-8	Indicate lamps .....	43
2-2-9	Function key (switch quantity operation) .....	49
2-2-10	Fold-line graph.....	50
2-2-11	Bar graph.....	51
2-2-12	Graph display.....	52
2-2-13	Dynamic messages.....	53
2-2-14	Alarm list .....	56
2-3	Save a project.....	59
2-4	Download the screen.....	59

---

<b>Chapter 3</b>	<b>Operation methods of OP320 .....</b>	<b>61</b>
3-1	Online communication.....	61
3-2	Shift the screen.....	61
3-3	System's password.....	62
3-4	Modify the data.....	63
	<b>3-5 Switch value operating.....</b>	<b>64</b>
Chapter 4	New addition function of OP520.....	66
4-1-2	Screen jump function.....	68
4-1-3	Advanced function.....	69
4-2	Status indicate lamp.....	70
4-3	Application examples of global function key and button indicate lamp.....	71
4-4	inside clock (optional).....	74
<b>Chapter 5</b>	<b>Application examples of OP520.....</b>	<b>76</b>
5-2	Analysis a project.....	77
5-3	Make a screen.....	78
<b>Chapter 6</b>	<b>OP320-S, OP320-A .....</b>	<b>93</b>
	<b>OP320-S.....</b>	<b>93</b>
	<b>OP320-A/OP320-A-S .....</b>	<b>93</b>
<b>Chapter 7</b>	<b>PLC's connection method .....</b>	<b>94</b>
7-1	xinje FC series PLC.....	94
7-2	Mitsubishi FX series PLC.....	95
7-3	Siemens S7-200 series PLC.....	96
7-4	Omron C series PLC.....	97
7-5	Koyo S series PLC.....	98
7-6	Schneider NEZA series PLC.....	99
7-7	DELTA DVP series PLC.....	100
7-8	LG Master-K series PLC.....	101
7-9	Matsushita FP series PLC.....	102
7-10	FACON FB series PLC.....	103
7-11	Kenyence series PLC.....	105

---

# Chapter 1 Summary of the products

## 1-1 Function

OP series is a mini human machine interface of programmable controller, which monitor and modifies the value and status of register or relay inside PLC, in this way the operator can control the machine easily.

OP series displays has the specialties as following:

- Draw pictures on the computer by edit software OP20, input Chinese characters and set PLC addresses freely, use serial port communication to download screen
- Download both communication protocol and screen's data to the display, need no PLC to compile communication programs
- Correspond wide PLC types, including Mitsubishi FX series、Omron C series、Siemens S7-200 series、 Koyo SG series etc.
- Has function of password protection
- Has clock inside (optional).
- Has function of alarm list, display the current alarm information each line and real time
- Button can be defined as function key, and can substitute some machine keys on the control ark
- LCD display with backlight STN
- The display's surface is made of IP65, waterproof and oil-proof.
- Can display bit graphs.

OP320 display has the specialties as the following:

- The communication port is RS232/RS422
- Seven keys can be defined as function keys, and they can substitute some machine keys on the control table
- LCD display with backlight STN. It can display 24 characters × 4 lines, i.e. 12 Chinese characters × 4 lines.

---

OP320-S display has the specialties as follows:

- The communication port is RS232/RS422, whichever is ok.
- LCD display with backlight STN. It can display 24 characters × 4 lines, i.e. 12 Chinese characters × 4 lines.

OP320-A display has the specialties as follows:

- 20 keys can be defined as function keys (12 of them can be defined as digital keys and for other use), and they can substitute some machine buttons on the control table
- Choose the communication format freely, RS232/RS422
- LCD display with backlight STN. It can display 24 characters × 4 lines, i.e. 12 Chinese characters × 4 lines.

OP320-A-S display has the specialties as follows:

- Choosing the communication format freely, RS232/RS422

OP520 display has the specialties as follows:

- 42 film buttons: 10 number keys, 32 function keys, in these function keys 16 can be defined freely with the card which can be drawn out.
- There are 16 button indicate lamps on the panel, which can be used to indicate PLC's status
- Choose the communication format freely, anyone of RS232/RS422/RS485 is ok.
- LCD display with backlight STN. The distinguish ratio is 320×240. It can display 40 characters × 15 lines, i.e. 20 Chinese characters × 15 lines.

---

## 1-2 General specification

### 1. Electric specification

Input voltage	DC20V~DC28V
Power consumption	Less than 4W(TYP2.0W)
Allow momentary power-cut	Less than 20ms
Voltage endurance	AC1000V-10MA 1 minute (between signal and earth)
Insulation resistance	DC500V- about 10M $\Omega$ (between signal and earth)

### 2. Environment condition

Ambient operating temperature	0~50 $^{\circ}$ C, with no condensate
Storage temperature	-20~60 $^{\circ}$ C
Environment temperature	20-85%, with no condensate
Vibration Resistance	10-25Hz (2G per 30min in X, Y, Z direction each)
Interfere immunity	Voltage noise:1000Vp-p, pulse width 1 $\mu$ s,1 min
Ambient atmosphere	With no corrosive air
Protect configuration	Fit the IP65

---

### 1-3 Product types

According to the differences of the keys and the size, OP series products can be classified to the following types:

	Products classification				
OP series	OP320	OP320-S	OP320-A	OP320-A-S	OP520
The number of keys	7		20		42
Size of the screen	3.7"				5.7"
The background lamps	LED				CCFL
The display color	Monochrome				
Communication port	RS232/ RS422	RS232/ RS485	RS232/ RS422	RS232/ RS485	RS232/RS422/ RS485
Shape and size	163.5W×101.7H×50.4D		172W×94H×30D		284W×194H×50D

---



## 1-4 Each part's name

### 1-4-1 OP320/OP320-S

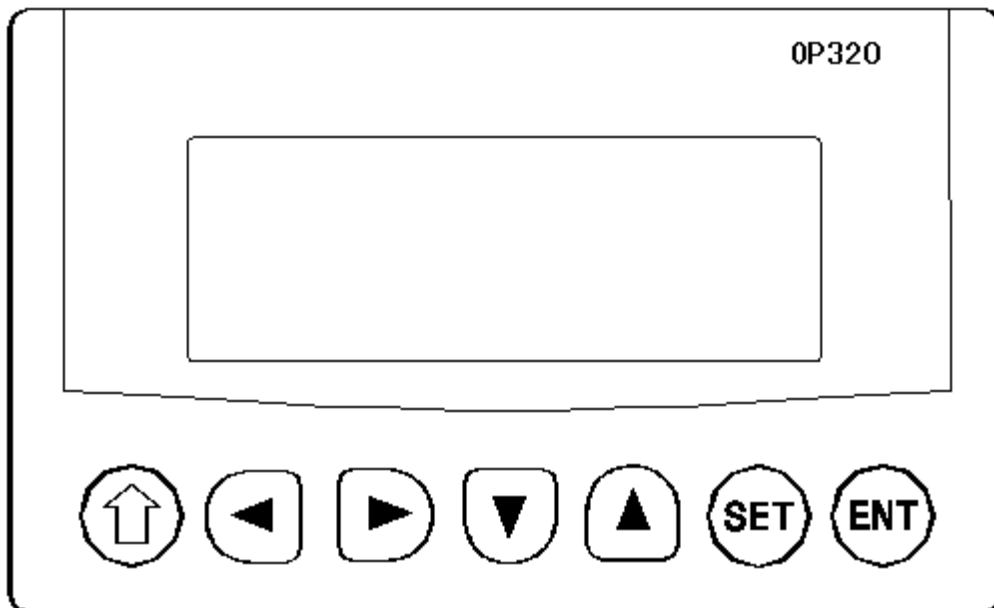
On the face of OP320(OP320-S), there is not only LCD display window, but also 7 machine buttons, it feels good to touch and be with long life、 safe and dependable.。 The seven buttons has not only the basic functions but also can be set to be special function keys, directly finish screen jump and on-off set and other function.



All the 7 keys can be defined to have special function. Such as bit set, bit reset and screen jumping etc. It can only execute the basic function if it has not been defined as special function. The basic functions include set register values, reset the initial screen, jump to the between the former or next screen.

Button	Basic function(These keys are not used as function keys)
[  ]	No matter which state the display is, once press this button, return to the system's initial screen. The system's initial screen is appointed by the user when designing the screen (The default value is the number 1 screen). Normally set the main menu or the screen which is used most often to be the system's initial screen.
[ ← ]	When modifying the register's data, shift the modified data bit to the left, that is: flicker displayed number shift a bit to the left.
[ → ]	When modifying the register's data, shift the modified data bit to the right, that is: flicker displayed number shift a bit to the right.
[  ]	Turn the screen to the former page, the former page's ID is appointed by the user in the screen's property (the default value is the current screen's No. minus 1) If in the status of data setting, the modified data bit plus 1, the increase range: 0—>9—>0
[  ]	Turn the screen to the next page, the next page's ID is appointed by the user in the screen's property (the default value is the current screen's No. plus 1) If in the status of data setting, the modified data bit minus 1, the increase range: 9—>0—>9
[SET ]	Press this key to start modifying register's value, the register window being modified currently display in the obverse color, and the modified bit display in flicker. If the current screen has no register set window component, then execute a no operation .Press [SET] key before press [ENT] key, then the current modify operation is cancelled and continue to modify the next data register.
[ENT]	Write the modified data to the register and then continue to modify the next data register. When the current screen's last register is being modified, exit the state of modifying register



---

At the back of OP320 (OP320-S), there are power terminal, communication socket and contrast adjusting potentiometer.

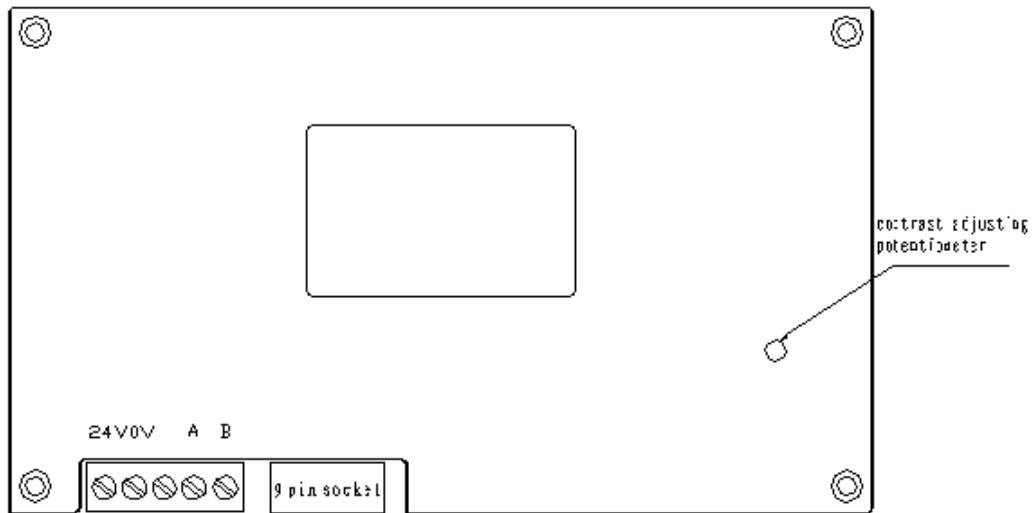

On the left of European-style terminal table is the exterior-connect DC power terminal, on the right is the connection interface of RS485 communication port. RS232 and RS485 communication ports are placed in the DB9 socket. When downloading the screen data, connect the 9 pin communication port of OP320 and that of the personal computer with communication cable OP-SYS-CAB. When communicating with PLC, make sure the communication port's connect format according to the PLC type.

During debugging, if you find that the contrast ratio of the LCD screen is not proper, you can screw the potentiometer in the back of the display with a small screwdriver till you find the contrast ratio be proper.

OP320 display has background lamp itself, as long as there is a button operation, the lamp will turn on, and it will auto turn off if there is no operation for three minutes continuously.

---

## 1-4-2 OP320-A/OP320-A-S

On the face of OP320-A (OP320-A-S), there is not only LCD display window, but also 8 film buttons, 12 number buttons and other function buttons. The 20 buttons can realize screen jump, switch function and special function. You can refer to OP520 for detail button definition.

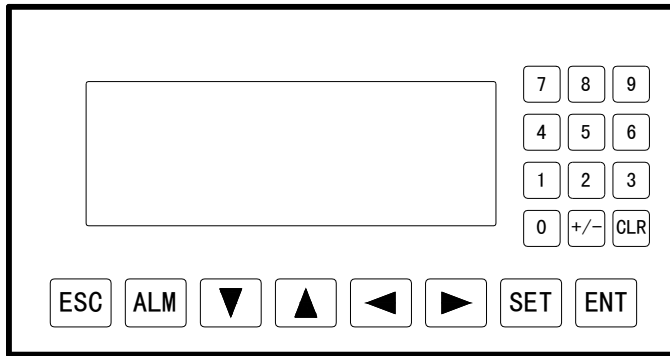











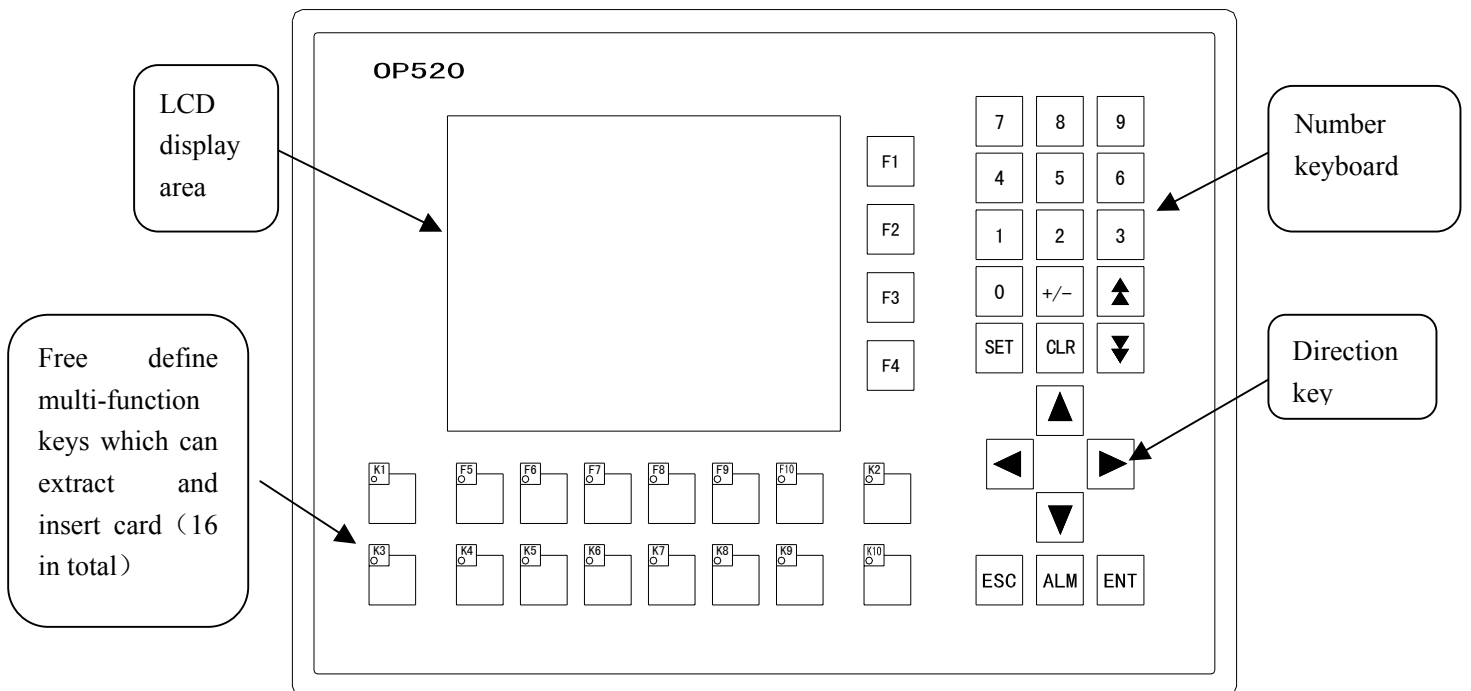

Table of keys' basic function:

Key	Basic function
	<p>No matter which status the display is, once press this key (When the key is not set as a function key), return to the system's initial screen. The system's initial screen is appointed by the user when designing the screen (The default value is the number 1 screen). Generally set the main menu or the screen which is used most often as the system's initial screen. It can also be used as a function key.</p>
	<p>It is used as a function key.</p>
	<p>It is used as a function key.</p>
	<p>It is used as a function key.</p>
	<p>It is used as a function key.</p>
	<p>Press this key (When the key is not set as a function key) to start modifying register's value, the register window being modified currently display in the obverse color, and the modified bit display in flicker. If the current screen has no register set window component, then execute a no operation .Press [SET] key before pressing [ENT] key, then the current modify operation is cancelled and continue to modify the next data register. It can also be used as a function key.</p>
	<p>Write the modified data to the register and then continue to modify the next data register (When the key is not set as a function key). When the current screen's last register been modified, exit the state of modifying register. It can also used as a function key.</p>
	<p>Alarm list key (When the key is not set as a function key), after setting alarm list function, press this key to fast switch to the alarm list screen. It can also be used as a function key.</p>
	<p>When modifying the register's data, clear the choosing area (When the key is not used as a function key). It can also be used as a function key.</p>
	<p>When modifying the register's data, set the data positive or negative(When the key is not used as a function key). It can also be used as a function key.</p>
	<p>Number key (0-9), in the status of number been set, the modified number bit change to the correspond key value (When the key is not used as a function key). It can also be used as a function key.</p>

## 1-4-2 OP520





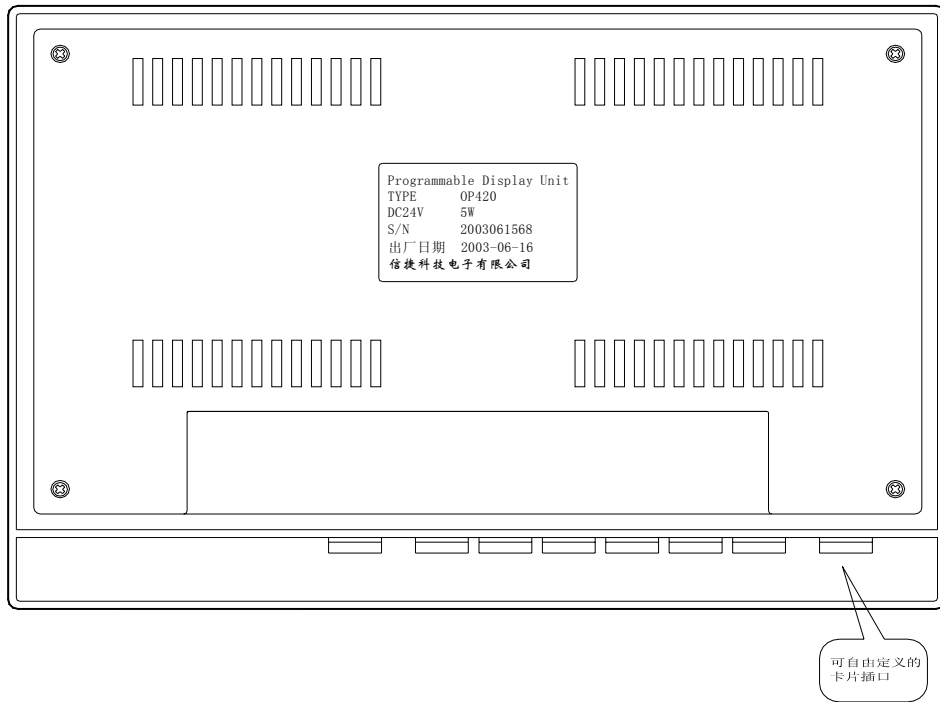







On the front of OP520, there are not only LCD display window, but also 42 film buttons, it feels good to touch, and the product has a long life, safe and dependable. You can overturn each screen and check its status with direction button; number keyboard can easily realize the input and modify of the numbers. Besides the basic functions the function button has, the user can define other functions freely when designing project screen with screen set tool. There are 16 buttons which can freely define their functions with the format of extract-insert card.





When using the card, the user can make different lattice printing on the card to realize making the needed special function button freely, which fits the products or the apply requirement of different environment.

**Button's basic function table**

Button	Basic function
	No matter which state the display is, once press this key (when the key is not set as a function key), return to the system's initial screen. The system's initial screen is appointed by the user when designing the screen (The default value is the number 1 screen). Generally set the main menu or the screen which is used most frequently as the system's initial screen.
	When modifying the register's data, shift the modified data bit to the left, that is: flicker displayed number shift a bit to the left.(When the key is not set as a function key)
	When modifying the register's data, shift the modified data bit to the right, that is: flicker displayed number shift a bit to the right. (When the key is not set as a function key)
	Overturn the screen to the former page(When the key is not set as a function key), the former page's ID is appointed by the user in the screen's property ( the default value is the current screen's ID minus 1) If in the state of data setting, the modified data bit plus 1, the increase range: 0—>9—>0
	Overturn the screen to the next page(When the key is not set as a function key), the next page's ID is appointed by the user in the screen's property ( the default value is the current screen's ID plus 1) If in the state of data setting, the modified data bit minus 1, the increase range: 9—>0—>9
	Press this key to start modifying register's value(When the key is not set as a function key), the register window being modified currently display in the obverse color, and the modified bit display in flicker. If the current screen has no register set window component, then execute a no operation .Press [SET] key before pressing [ENT] key, then the current modify operation is cancelled and continue to modify the next data register.
	Write the modified data to the register and then continue to modify the next data register(When the key is not set as a function key). When the current screen's last register been modified, exit the state of modifying register
	Alarm list key, after setting alarm list function, press this button to fast switch to the alarm list screen。 (When the key is not set as a function key)
	When modifying the register's data, clear the choosing area
	When modifying the register's data, set the data positive or negative
	Number key (0-9), in the state of number been set, the modified number bit change to the correspond key value。
	When modifying the register's data, choose the former data set window
	When modifying the register's data, choose the next data set window

<b>Kn</b>	Can use as global function key or normal function key
<b>Fn</b>	Can use as global function key or normal function key

There are four ports underside the display, from the left to right, they each are : 24V power input terminal, project screen download port, communication port and extendable communication port.

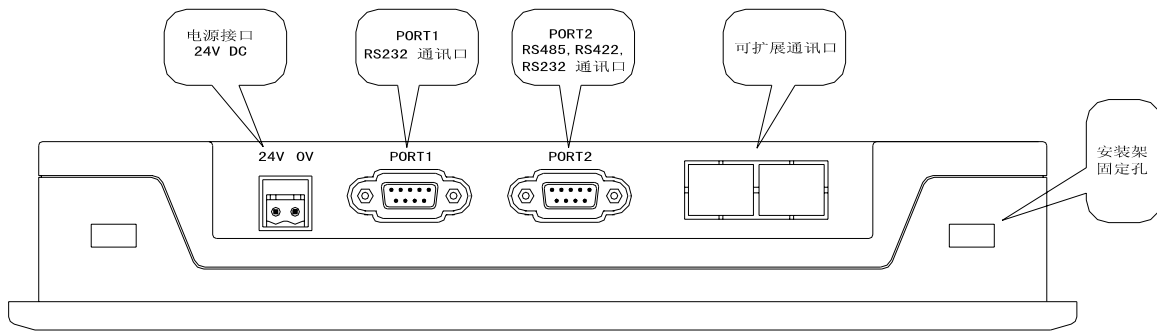

Display's 24V power input terminal take European style terminal table which can extract and insert as the power port. It's convenient to operate. PORT1 is RS232 communication port. When downloading, connect 9 pin communication port of OP520 and computer's 9 pin communication port with communication cable DP-SYS-CAB. Click "download" button to transfer the designed project screen to OP520. There are three communication manners for PORT2: RS232, RS422, RS485. Connect OP520 and every series of PLC with the communication cable, and you can realize the communication between OP520 and PLC. According to the user's requirement, the user can choose any of the three communication manners freely. When communicate with the different PLC, use the different communication cable.

In the OP520's classical collocation, the extendable communication port is space collocation. You can collocate it to the user's detail requirement.

OP520 display screen has CCFT backlight with itself, it is off in the process of downloading, and it will lit in other conditions.

There are four stainless steel fixed bracket along with OP520 when it leave the factory.

# 1-5 Interface definition and connection graph

## 1-5-1 OP320

Serial communication port pin's ID number of OP320.

Pin ID	definition
1	TD+
2	RXD
3	TXD
4	
5	GND
6	TD-
7	
8	RD-
9	RD+

OP-SYS-CAB connecting graph

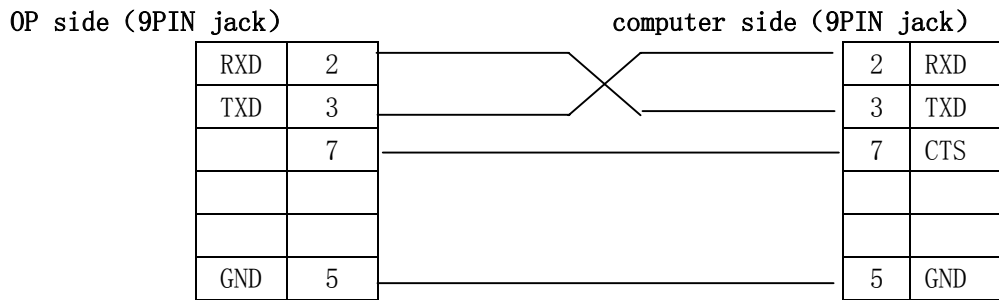

OP-SYS-CAB connecting graph: (V4.0):

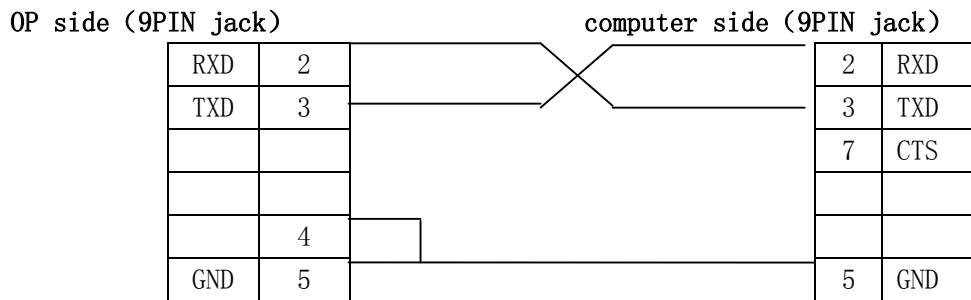



## 1-5-2 OP320-S

Serial communication port pin's definition ID number of OP320-S.

Pin ID	Definition
1	TD+
2	RXD
3	TXD
4	
5	GND
6	TD-
7	
8	B
9	A

OP-SYS-CAB connecting graph:

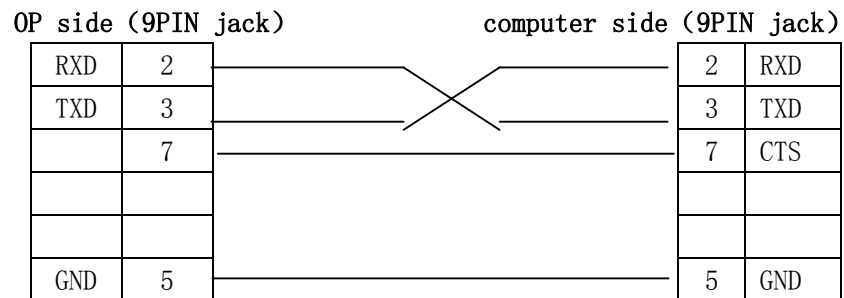

OP-SYS-CAB connecting graph: (V4.0):

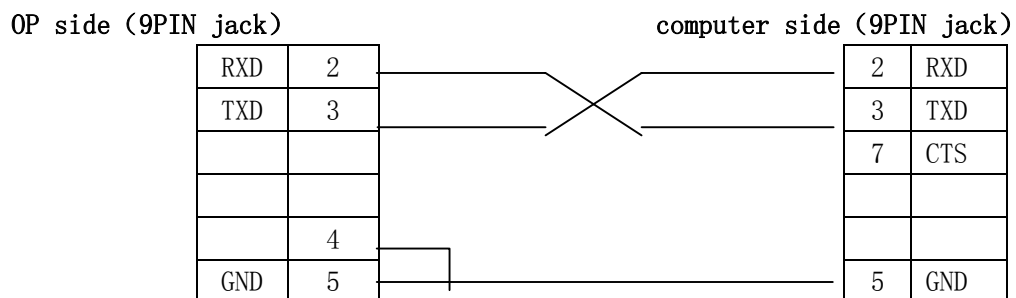

---

### 1-5-3 OP320-A

Serial communication port pin's definition ID number of OP320-A.

Pin ID	Definition
1	TD+
2	RXD
3	TXD
4	
5	GND
6	TD-
7	
8	RD-
9	RD+

OP-SYS-CAB connecting graph:

OP side (9PIN jack)

computer (9PIN jack)

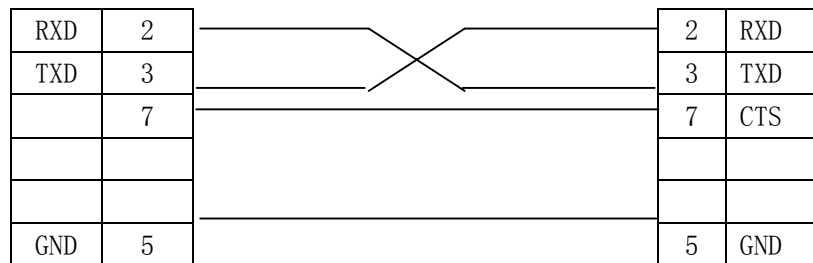

OP-SYS-CAB connecting graph: (V4.0):

OP side (9PIN jack)

computer (9PIN jack)

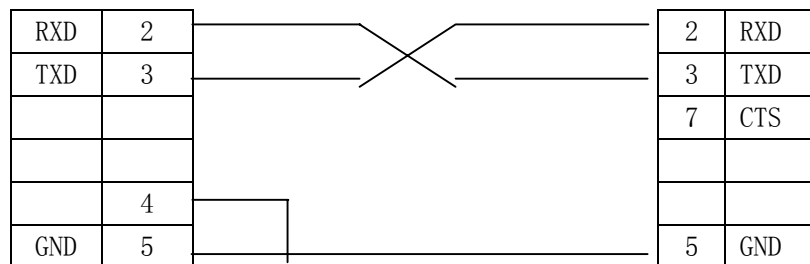

## 1-5-4 OP320-A-S

Serial communication port pin's definition ID number of OP320-A.

Pin ID	Definition
1	TD+
2	RXD
3	TXD
4	
5	GND
6	TD-
7	
8	B
9	A

OP-SYS-CAB connecting graph:

OP side (9PIN jack)

computer (9PIN jack)

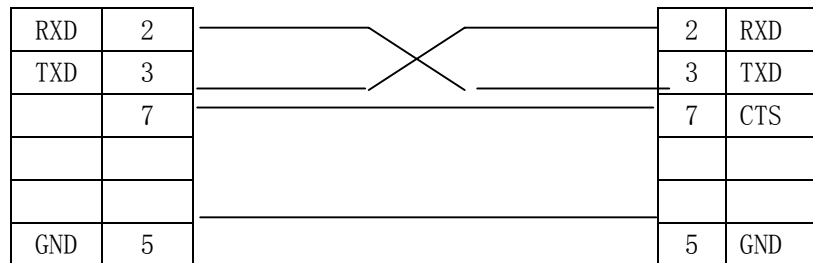

OP-SYS-CAB connecting graph: (V4.0):

OP side (9PIN jack)

computer (9PIN jack)

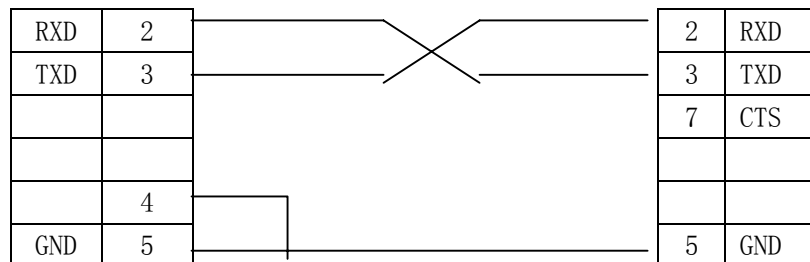

---

## 1-5-5 OP520

Serial communication port pin's definition ID number of OP520.

PORT1 (download port):

Pin's ID	Definition
1	NC
2	RXD
3	TXD
4	NC
5	GND
6	NC
7	RTC
8	NC
9	NC

PORT2 (communication port):

Pin's ID	Definition
1	TD+
2	RXD
3	TXD
4	Empty
5	GND
6	TD-
7	空
8	RD-
9	RD+

OP-SYS-CAB connecting graph:

**DP210 (9PIN holes)**

**Computer (9PIN holes)**

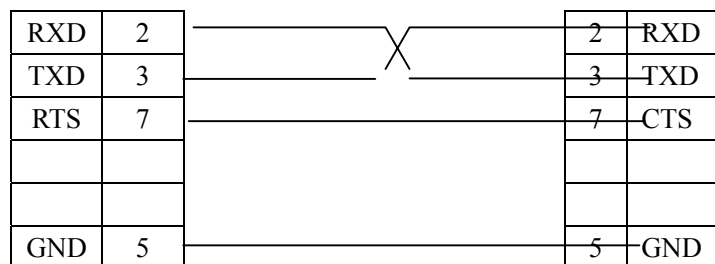

---

## 1-6 Sizes and installing methods

OP320 (OP320-S) The product's actual size: 155.5×92.7×50.4 (in mm)

The install size: 156.5×94 (in mm)

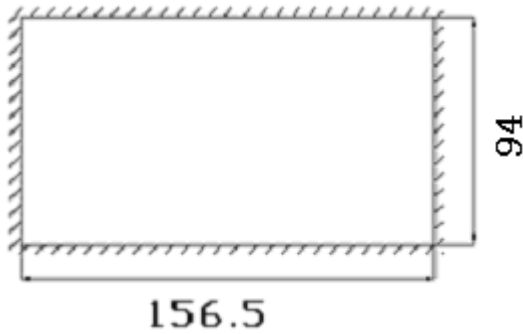

OP320 -A (OP320-A-S) The product's actual size: 162.2×84.2×30 (in mm)

The install size: 163.2×85.2 (in mm)

(It's just for reference, please take the real product's size as the standard.)

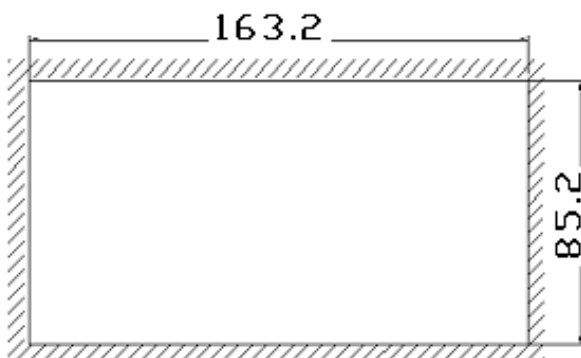

OP520 The product's actual size: 284×194×50 (in mm)

The Install size: 269.2×156.4 (in mm)

The install schematic diagram is the following:

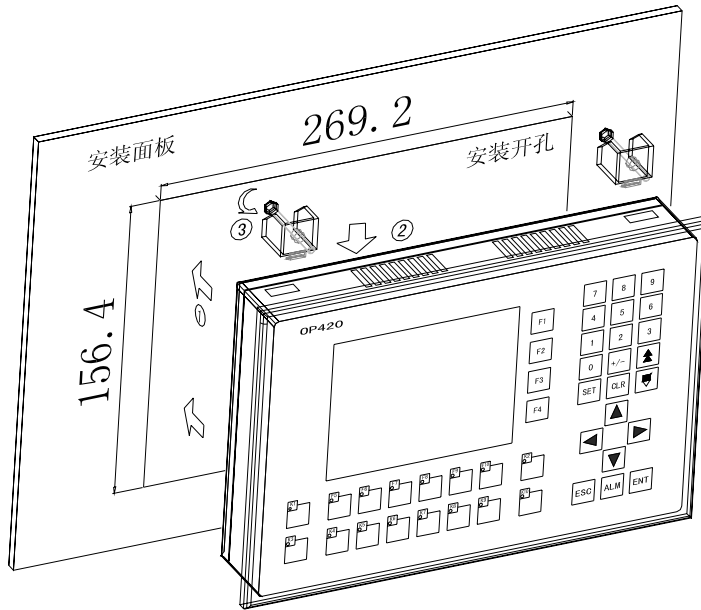

The detail install steps:

Step 1, Dig holes on the install panel, refer to the up graph for the hole's sizes.

Step 2, According to the direction arrowhead① point, put OP520's bottom to the install hole.

Step 3, According to the arrowhead② shows, put the install fixed bracket to the install hole.

Step4, twist the screws on the four fixed bracket according to arrow ③, make sure that the display's bottom and the install panel is contact closely. If there is no obvious bend in the fixed panel, then end.

Note: Refer to OP520 for the installation of OP320, OP320-A, OP320-S

Some points to note when installing:

1 The sizes of install holes must be appropriate, leave a certain space around, do not clip too close to avoid damage the display's crust. You can refer to the dimension given in the graph

2 Do not twist the screws of install bracket too close to avoid damage the display's crust.

3 The four bracket's screws should be under the even force, screw them down will be ok , do not give them

too much force, no obvious deformation will be good.

4 You'd better add a seal rubber in the seal trough.

---

## **Chapter 2 Editor Software OP20**

### **2-1 Basic summary of OP20**

OP20 is the exclusive develop software for character display: OP series application screen. It runs below WINDOWS 98/2000 system. As a second develop tool, the software is convenient to use, easy to learn and can set Chinese and English characters directly.

#### **2-1-1 About the project and the screen**

For a product, all the screens the user made are saved in a project. The project's basic element is screens. Each screen realizes a certain function. Via designing, different screens can jump freely. All the screens make a group, and the group is the application project file developed by the designer.

#### **2-1-2 The content of screen**

After open a project, the user can create a new screen or open a screen. You can place Characters (Chinese or English), indicate lamp, switch, data display set window, jump key and other element in each screen. Also, you can realize screen jump freely, the operator can finish the operation of data monitor, parameter setting, on-off control, alarm list monitor etc.

---

### 2-1-3 The use flow of OP20

The basic use flow of OP20 is the following:

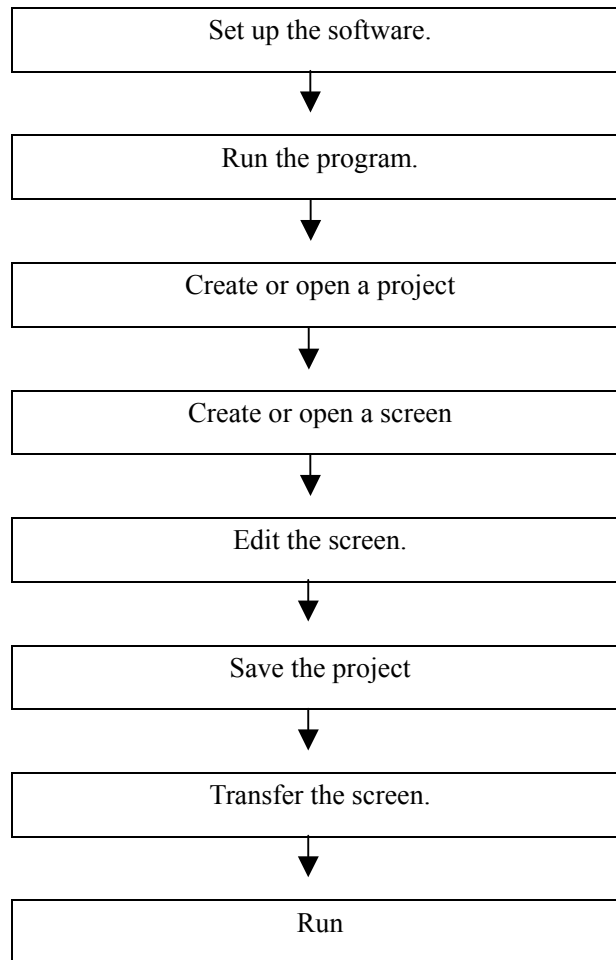



---

## 2-2 Edit the user's screen

### 2-2-1 Create a project

After running the OP20 Software, There will be a screen editor in the center of the computer's display.

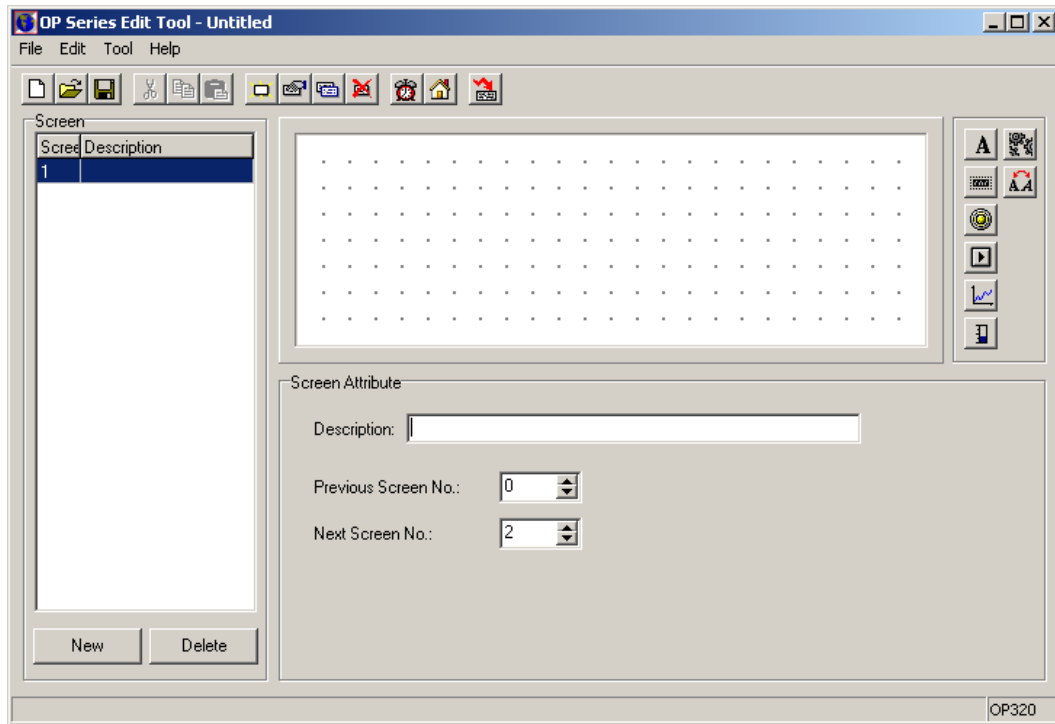













- Screen
  - Display all the screen's serial number in the project.
- Description
  - Simply character description of the screen function
- “New” key
  - Create a new screen.
- “Delete” key
  - Delete the current screen.

In the top of the editor are the menu and tool bars; the content in the left form is the screen's number and its description. In the bottom of this column there are [new] and [delete] buttons, they are used to create a screen or delete the current screen.

In the center of the editor is the screen edit area. In the display area evenly place light gray lattice, the space of the two dots is 16 pixels. The whole screen is 192×64 lattice. When the designer place or move any element, refer to the near dot's place in order to snap the element to the grid. When the designer drag the element to move it with the mouse, the move space is integral times of 4 dots.

The following is all the keys in the tool bar and their function description.

Key	Description
	Create a new project.
	Open a saved project.
	Save a project that is editing currently
	Cut the characters in the textbox.
	Copy the characters in the textbox.
	Paste the characters in the textbox.
	Create a new screen, its function is the same to the [new] button in the screen indicate window.
	Display the property content of the current screen.
	Copy a screen to be another one
	Delete the current screen.
	Point the system's initial screen, when the display is working, click the [↑] button to return back to this screen directly. Generally, this screen is main menu or used most often. Set the system's password; Set the alternate control register's define ID.
	Log in the alarm list information, each piece of alarm information correspond with a middle relay.
	Via RS232 port of the computer, download the completed project file to OP320 display.

Note: If you want to delete any element in the screen, just choose “DEL” button to realize.

Click on the  button or click [file]→[create a new project] command, in the center of the screen there will pop out a dialog box for you to choose PLC's type

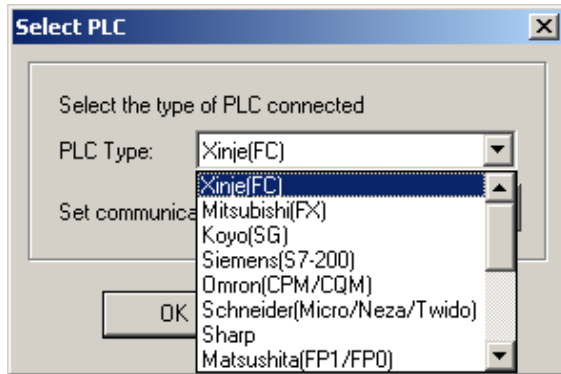

### ➤ PLC type

Choose PLC's type according to the display's communicate object. When OP20 download the screen, transfer the appoint PLC's communication protocol along with the screen data to the display. When the display is working, it will communicate with PLC according to this protocol.

## 2-2-2 Make a basic screen

The following we will take Mitsubishi FX series PLC as the example to describe:

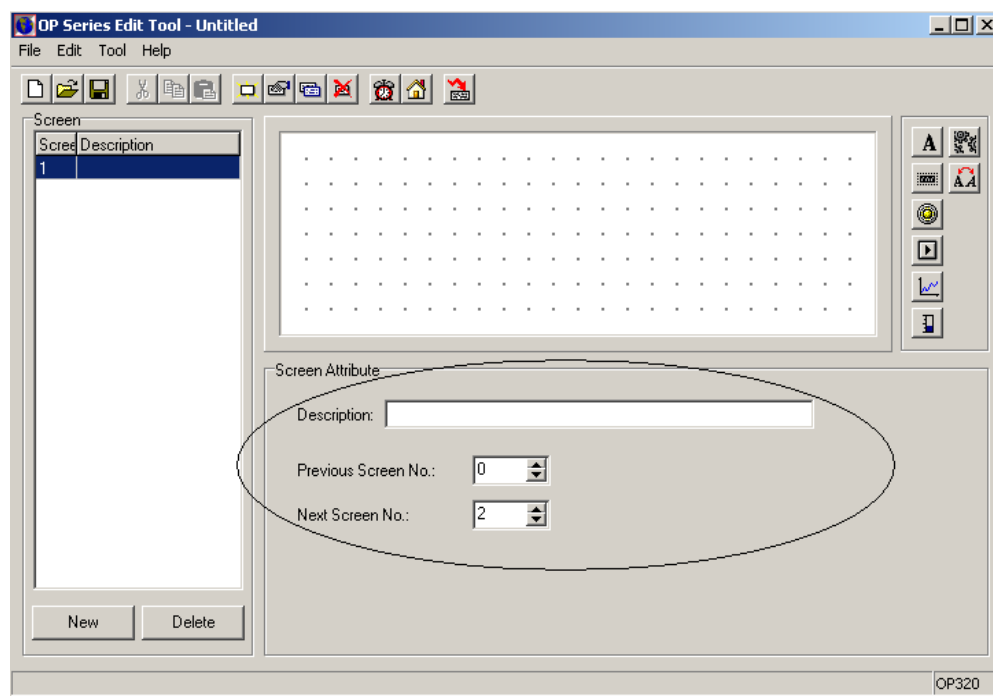

---

First, enter the edit status of the system's initial screen (If default it will be the No.1 screen). In the bottom of the screen is the current screen's (No.1 screen) property, each screen has the property, include three items of the content.

➤ Screen description

Describe the screen's property, enable the designer to manage conveniently. It only has the function of clue, so it also needn't to fill in. Take an example to input "main menu"

➤ Click [^] button to the screen's No.

The value is click [^] button, the display will jump to the screen's No.

➤ Click [v] button to the screen's No.

The value is click [v] button, the display will jump to the screen's No.

When the display is running, click [] button, [^] button or [v] button is the most brief way to switch the screens. Moreover, you can also realize screen jump by setting the function key.

Note:

- a. If the [^] button or [v] button in the current screen is set as the function key, then the screen jump parameter in the screen's property is of no use.
- b. If the screen appointed by [^] button or [v] button does not exist, then the actual jump screen's ID spread up or down in turn, stop by 1 when up.
- c. If there are data set elements in the screen, then in the process of data setting, [^] button or [v] button realize the function of data plus or minus. After exit data setting state, [^] button or [v] button can recover the function of screens jump again.

### 2-2-3 The system parameter of OP20

Click  button, or click "tool"→"set OP20" command, there will come out a dialog box of setting OP20's system parameter

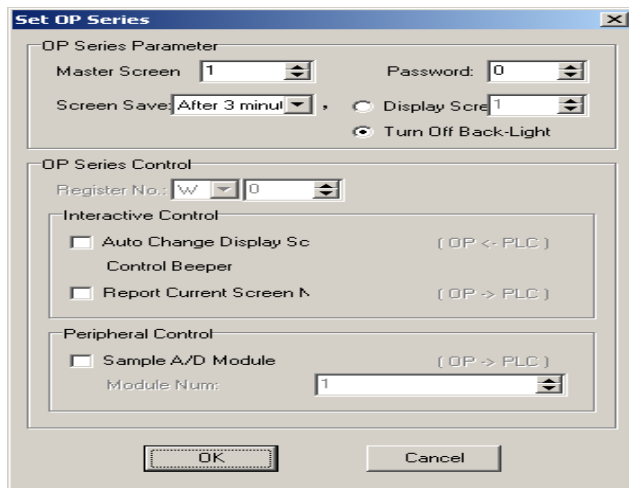

- The main control screen

After giving it power, the first screen OP320 displays. Generally, set this screen to be the main menu screen or the screen that used most often. During running, click [↑] button can jump to this screen directly.

- Password

All the screens in a project use a same password, when the encrypt property of “data set window”, “function key” is valid, only when the system’s password be opened can the elements execute the action. Using this function you can easily realize screen hide and set data encryption.

- Power conservation protection

The default value of the backlight hold time is 3 minutes. When set it to be 0, the backlight will light from start to end.

- Alternate control

Normally, screen switch is realized by the buttons. Besides, PLC can also realize screen switch by modifying the register’s value. If this property is valid, write value n to the register D300 when running. OP20 will auto switch the display to the No,n screen. After this value in D300 will auto set to be 0.

OP320 writes the current screen’s ID number to D301, PLC can also know the status of the display in this way.

Note: Designer can define the ID number of alternate control register in this way.

- Sample analog quantity data









OP320 can connect with a 8-route analog quantity sample module or a 8-route temperature sample module via RS485 communication port.

The register’s head address which analog quantity auto stores is assigned by this parameter.

---

## 2-2-4 Text

Before editing the screen, describe the 8 elements' function in the right of the screen edit window.

Parts	Function
	Input texts, including Chinese characters and English letters.
	Lay data monitor window or data set window (The object is PLC data register)
	Indicate lamp, display the on-off status of middle relay inside PLC.
	Function key, all the seven keys in the bottom of OP320 can be defined as function keys. The usage of function keys include screen jump and switch control etc.
	In the process of industry control, some parameters changes slowly, the operator want to know the change process of these parameters in a certain time. Fold-line graph is the most ideal format.
	Bar is used to display analog quantities parameter intuitively, such as flux, pressure, liquid level, etc. Its height, width and direction can be appointed randomly.
	Insert a bitmap file, it can display the machine's graph, make the operator easy to understand. It can also display the mark and badge of the factory, improve the product image.
	Dynamic text, display the current status of the machine with dynamic text. Make the operator easy to operate, improve the produce efficiency. Dynamic text is your ideal choice.

The following, we will take the example of designing the NO.1 screen to be the main menu screen.

First, lay the text “main menu”, click the  button, there will be a rectangle dashed frame in the screen, and it moves along with the mouse. The move distance is integrate times of 4. At this time, click the left key of mouse to confirm, and click the right key of mouse to cancel. After confirming, the default content “Message” will display in the window, at the same time there will be the message's attribution displays in the right bottom of the screen.

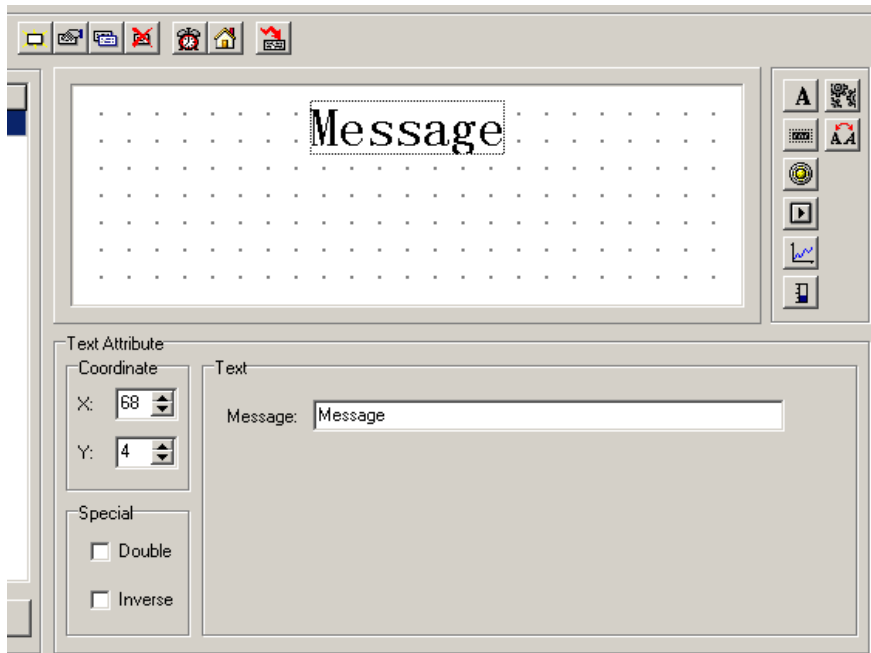

➤ Coordinate

The X value indicates this text's horizontal position

The Y value indicates this text's vertical position

The coordinate origin point is in the left top of the screen.

➤ Special

Double: Display the characters multiply in horizontal and vertical.

Inverse: The color of the message and the background displays inversely.

➤ Message

The actual display content, we can input Chinese characters or English letters directly with all the Chinese input methods. The content of this column can be cut, copied or pasted.

E.g. Display the text "main menu" in inverse. Input "main menu" in the set column, and choose the "inverse" in the "special" frame.

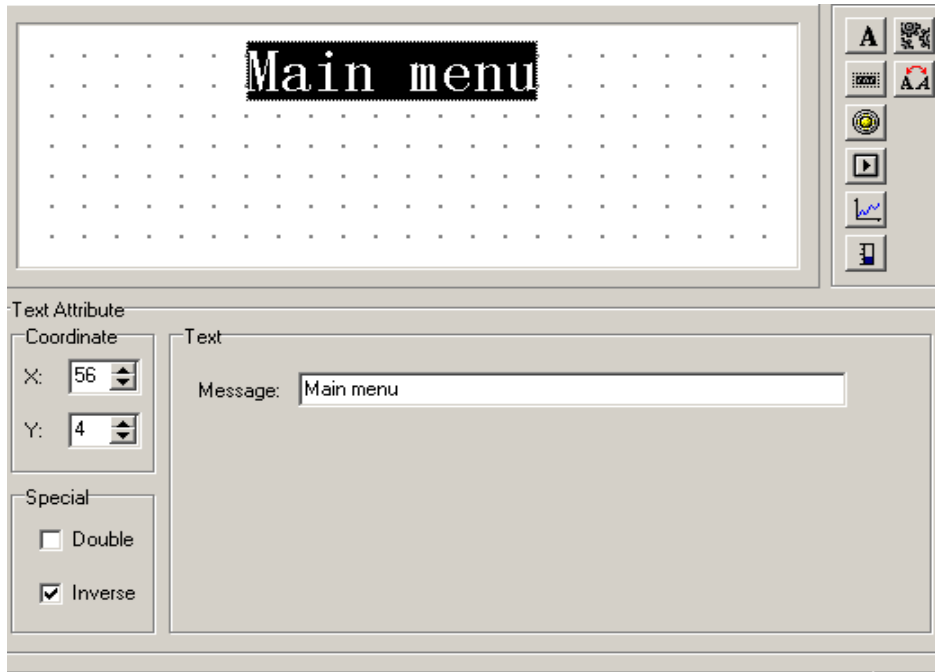

## 2-2-5 Function key (screen jump)

The following, set function key in the main menu screen to realize screen jump function. E.g. when running, click “<” key to enter parameter set screen. Click “<” key to enter mode set screen. The steps of set function key is the following:

Click  button, there will be a dashed rectangle frame that moves with the mouse. Click the left button of the mouse to confirm the position of the function key. Then there will be a hand graph and the function key(Be “<” when default) to be set in the window. In the right bottom is the attribution of the function key, in which the coordination and its attribution is the same with the text’s. It is used to indicate the position, conform the graph’s size and color.

### ➤ Key

In the pull down menu of “key”, choose the appropriate key from seven keys.

### ➤ Hand

In order that the operator can operate it correctly and quickly, add a hand graph in front of the button, indicate that press the appointed key can complete an action. In order to save the space, you can also not choose the hand graph.

### ➤ Encrypt

This function key is only valid when the system’s password be opened.

### ➤ Set coil



---

The function key's action is switch quantity setting.

- Screen jump

This function key's action is screen jump.

- Coil No.:

When the function key's action is switch quantity setting, conform PLC's interior middle relay's define ID number correspond with on-off action.

- Force ON

Set the appointed middle relay to be ON.

- Force OFF

Set the appointed middle relay to be OFF.

- Reverse

Set the appointed middle relay to be the reverse logic.

- Momentary ON

When the key been pressed down, set the appointed middle relay to be ON; when the key pop up, set the appointed middle relay to be OFF.

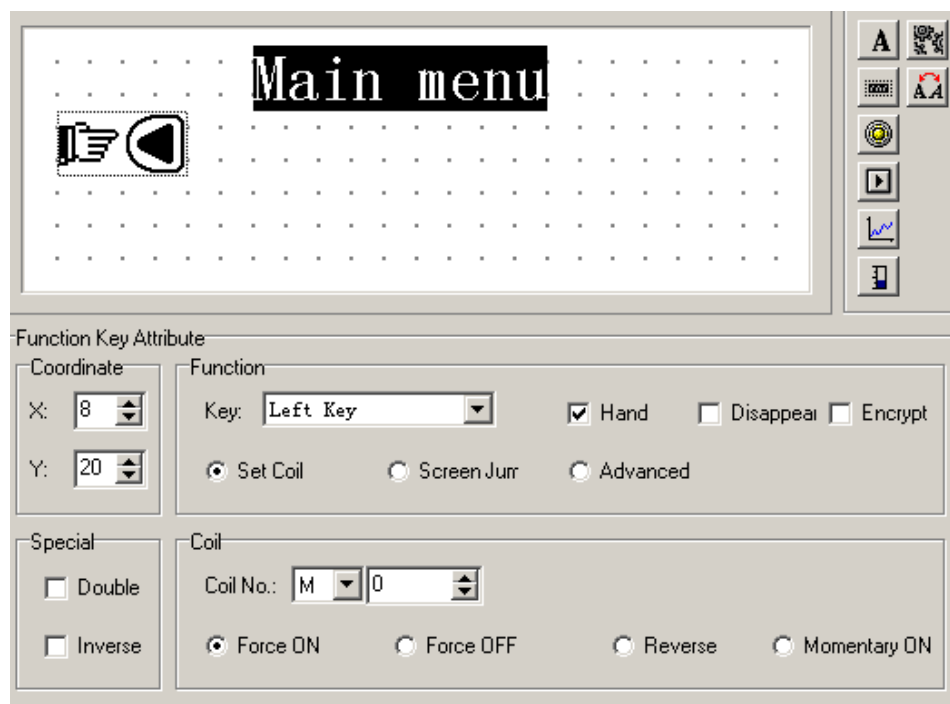

In the pull-down menu of “key”, there are seven keys. Choose the appropriate one among these.

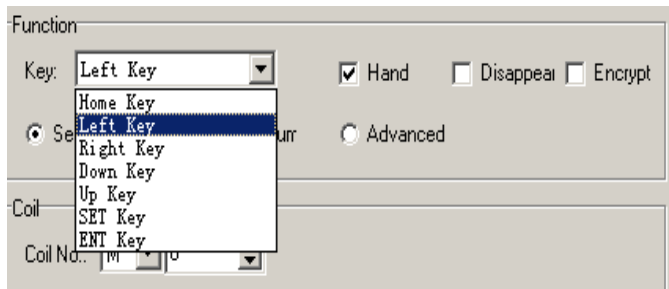

Considering to be brief, you can cancel hand display, then in the screen there will be only a button. After this set the function to be screen jump, here underside the screen set the jump screen's ID number. Set the target screen's ID number to be 10, i.e. the tenth screen is the parameter set screen.

In order to hide the set screen, set the "Encrypt " property to be valid. Only when the system's password be opened can it jump to the NO.10 screen.

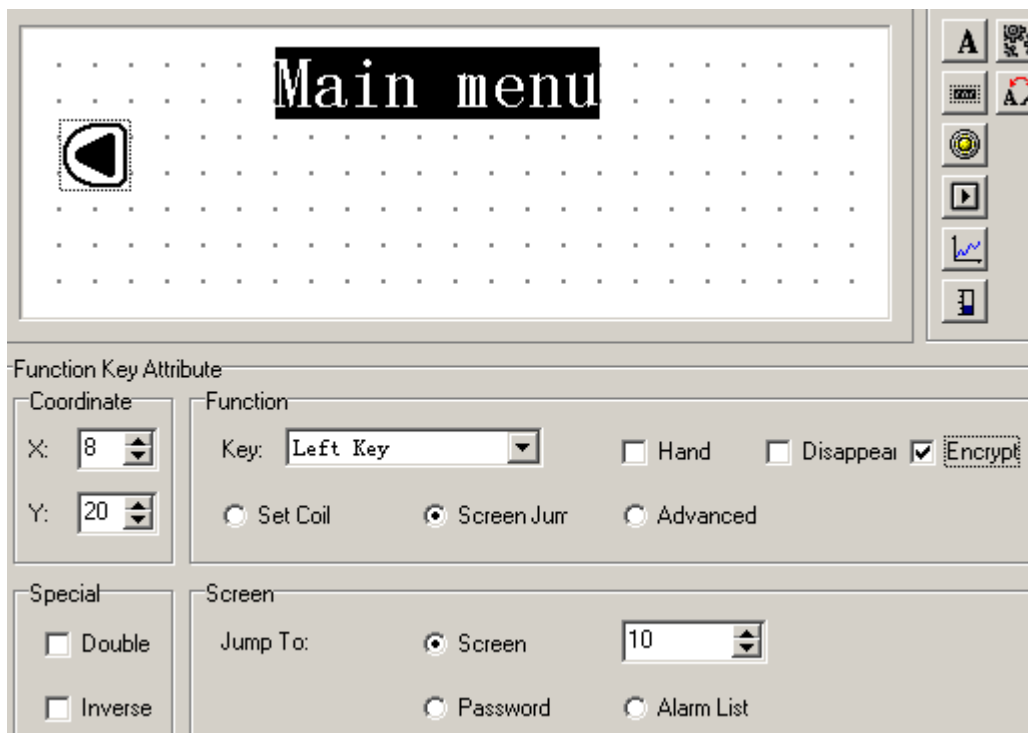

After set the function key, place text "set parameter" to the right of the button graph to prompt the operator. Click "<" key to enter parameter set screen directly.

In the same way, place function key ">" and "state setting" in the right of the screen, that means click ">" key to enter state set screen.

You can set the NO.20 screen to be the state set screen.

Note: In order to insert a new screen , you'd better separate the screen's No. of the different type of screens. E.g. if you want to add a parameter set screen, you can place it to the No.11 screen.

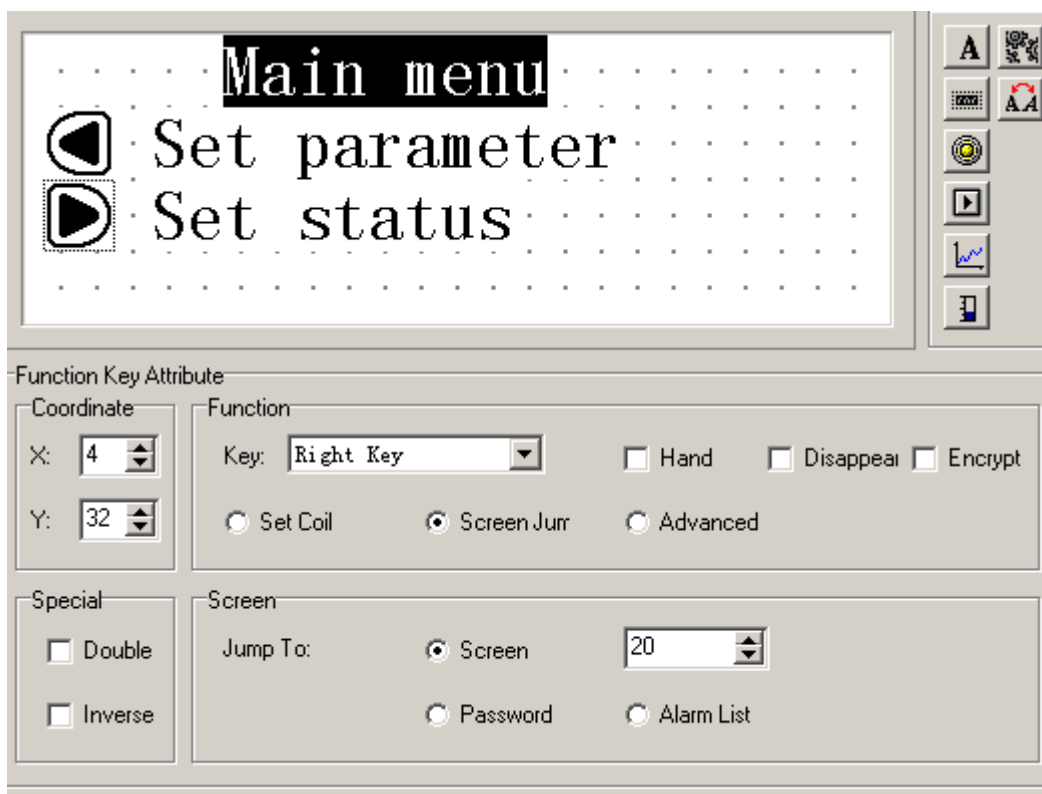
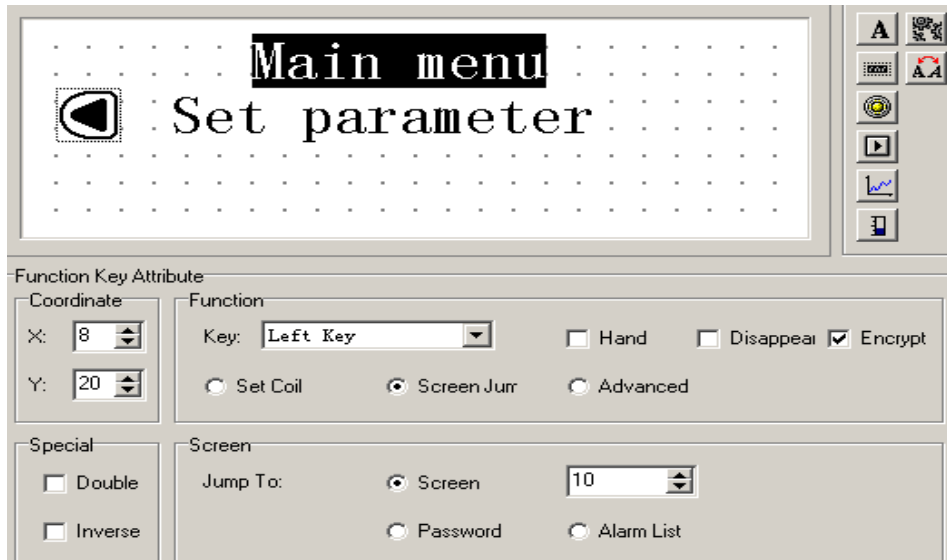

In the main menu screen, add an alarm screen jump key. When click this key, you can jump to the alarm list screen, refer to the alarm information.

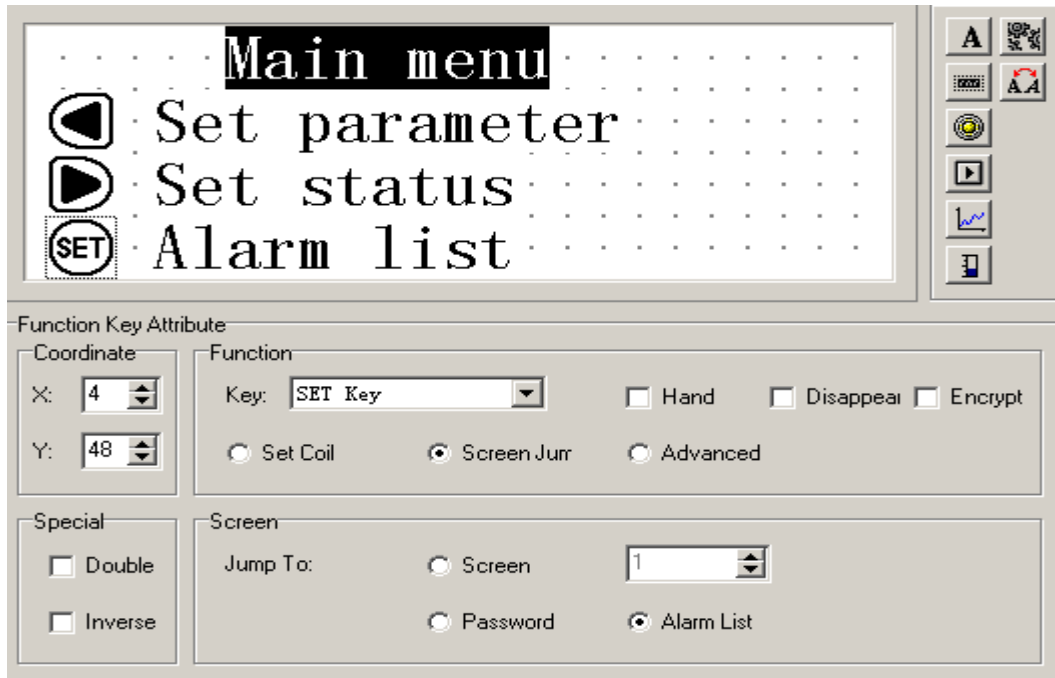

For the methods of log in the alarm information, you can refer to 2-2-14

## 2-2-6 Data display window

The following, we will introduce how to make a parameter set screen. At the same time, we will tell the set methods of parameter display window and parameter set window in details. Also, we will tell you how to set the password.

E.g. The NO.10 screen can monitor and set three groups of parameters, correspond respectively with the production of Class A, Class B, Class C. The row in the left is the current value, the row in the right is the target value. The current value can only be used to monitor the data, the target value can not only monitor but also modify the data. The correspond relationship between the three groups of parameters and PLC data register is the following:

	The correspond address of the current value	The correspond address of the target value
The production of Class A	D100	D110
The production of Class B	D101	D111
The production of Class C	D102	D112

---

The graphic steps are the following:

Click the [new] button, then there will be a dialog box of the screen's ID No. and screen description setting:

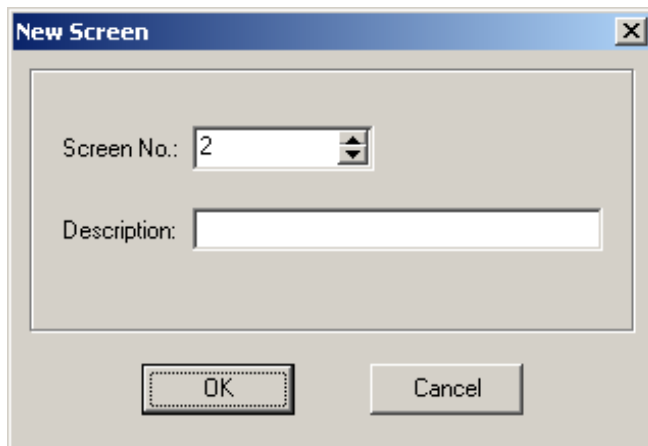

➤ Screen No.

The new screen's ID number

➤ Description

Describe the new screen's property.

Set the screen No. to be 10, enter the screen description "set parameter".

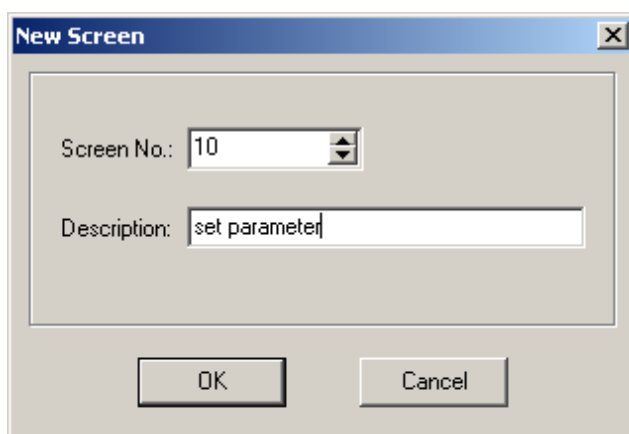

Click [OK] button to confirm. After that, there will be the content of screen attribute in the right bottom of the screen. Set the "Previous Screen No." to be 0, set the "Next screen No." to be 20. Then in the normal display status (not in the status of data setting), click "^" key to directly enter the main menu screen, click "v" key to directly enter the state setting screen

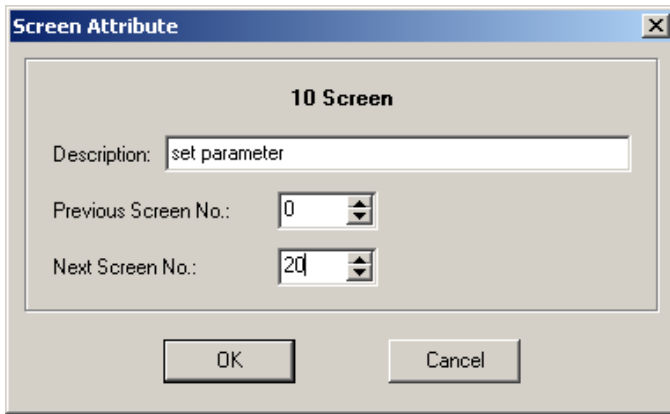

At the proper position, place text “the current value”, “the target value” , “the production of Class A”, “the production of Class B”, “the production of Class C”.

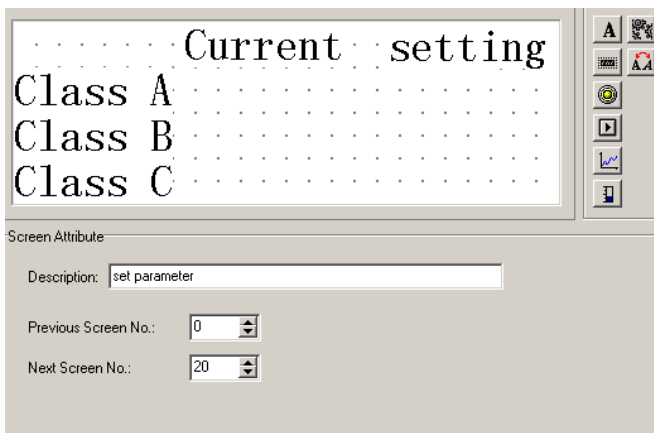

Lay the data display window, click the  button, there will be a rectangle dashed frame moves with the mouse, move it to proper position, then click on the left button of mouse to confirm it.

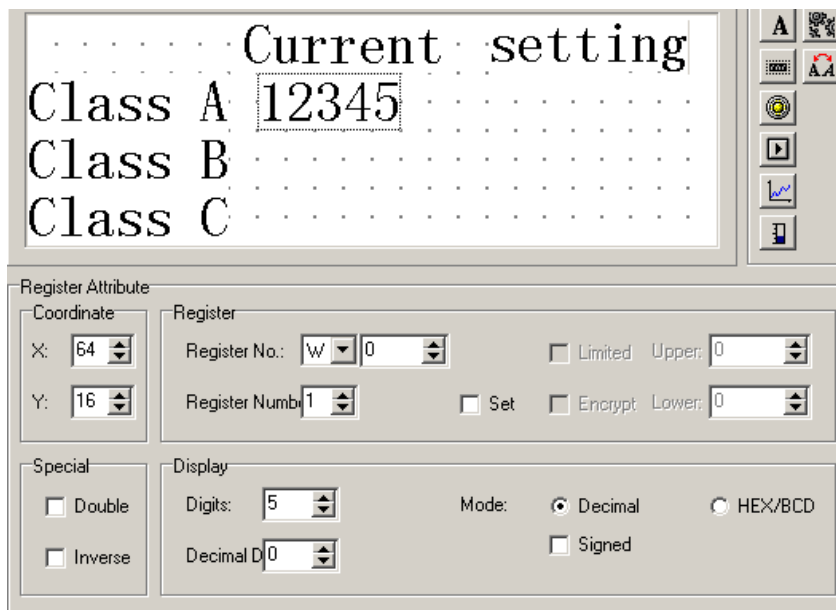

Display “12345” these five numbers inside the dashed frame, that means that this element is a register display window or register set window whose length is five bits.

- Register No.

PLC register’s define No. corresponds with display’s elements.

- Register number

Sequential display or set the number of registers, the minimum is 1, the maximum is 2.

- Set

This part has the function of set. It can not only monitor but also set the data. Register set window has the properties of up limitation, low limitation and encryption.

- Upper/lower limitation

Allow set the data’s max value and mini value.

- Encrypt

Only when the system’s password been opened can you modify the data, the password value is set by the tool menu.

- Digits

Display or set the data’s max digit.

- Decimal

The number of digit bits after the dot.

- Decimal system

Display the data in the register in decimal system.( recommend the PLC of Mitsubishi and

---

Omron to choose this form.)

➤ Signed

Select this property only when display data in decimal format, if the highest bit of the register is 1, then display the data in negative. e.g. FFFE<sub>H</sub> equals -2.

➤ HEX/BCD

Display the data in HEX.

In this example, set by the following contents:

Register's address = D100; the number of register = 1; the digits of data =4; the digits of decimal fraction = 0; display in decimal system; not display negative data.

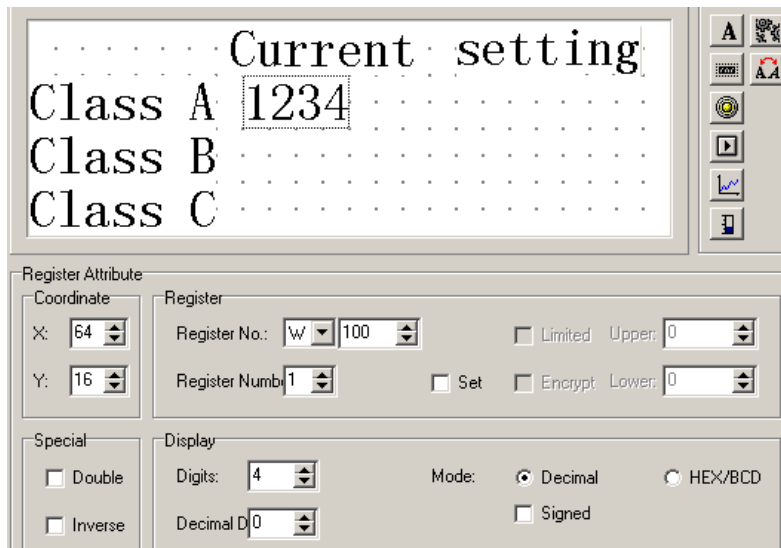

Set the current values display window of Class B and Class C with the same method. The addresses of registers are D101 and D102 respectively, other properties are the same as before.

## 2-2-7 Data set window

Continue to set the setting window. Click  button, there will be a rectangle dashed frame which moves with the mouse in the screen. After moves to the proper position, click on the left key of mouse to confirm. In the register column, choose "set", that indicates that besides the monitor function, the element also has set function.



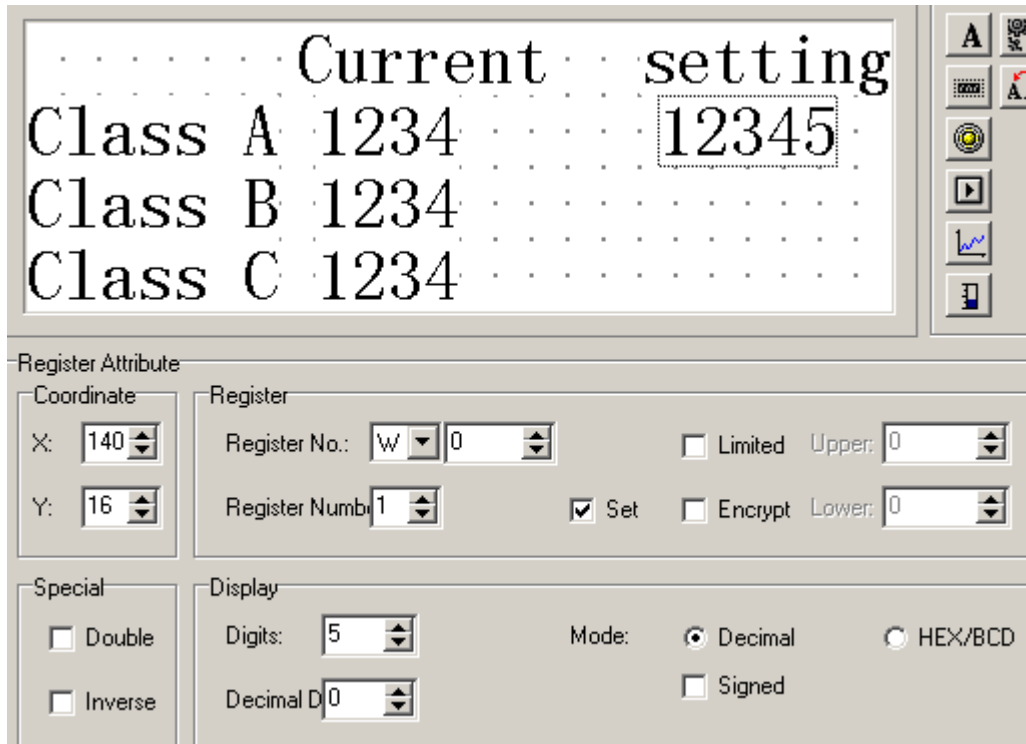

After the frame “Set” been chosen, add another two options: “Encrypt” and “upper/lower limitation”.

Encrypt: in order to improve the device’s reliability, all parameters can be protected by password. The methods of setting and modifying the password is the following:

Trigger “tool”→ “set OP20” command, there will be a dialog box: set OP series:

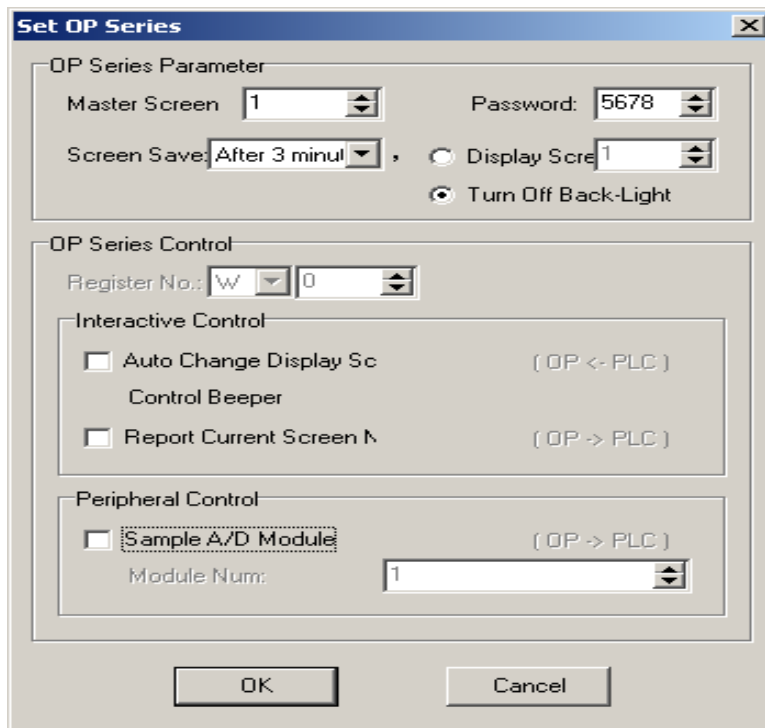

---

Input the password or modify the original password, e.g. input password “5678”, then press “OK” button, the password is confirmed.

When the display is running, the operator press down the “free define jump password key”, the display will pop out the password setting screen, only when the operator input the password “5678” can he modify the appointed data. A project uses a same password.

Upper/lower limit: the designer can set the upper/lower limit, the data which is over the upper/lower limit is valid. This will avoid input too large or too small data and damage the device. E.g. set the upper limit to be 9000, the lower limit to be 0. Only when  $0 < \text{the set value} < 9000$  can the set value be written into PLC. Or else wait to set a new valid value.

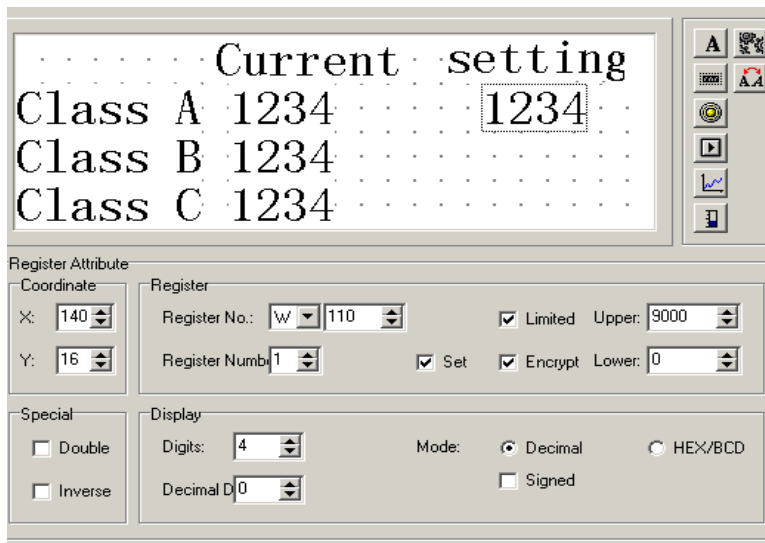

Set the other properties in turn: register No. = D110; Register number = 1; Data digits = 4; Decimal number = 0; display in decimal system. Set the production set window of Class B and Class C with the same method. The set value of Class B corresponds with D111, and the setting value of Class C corresponds with D112.

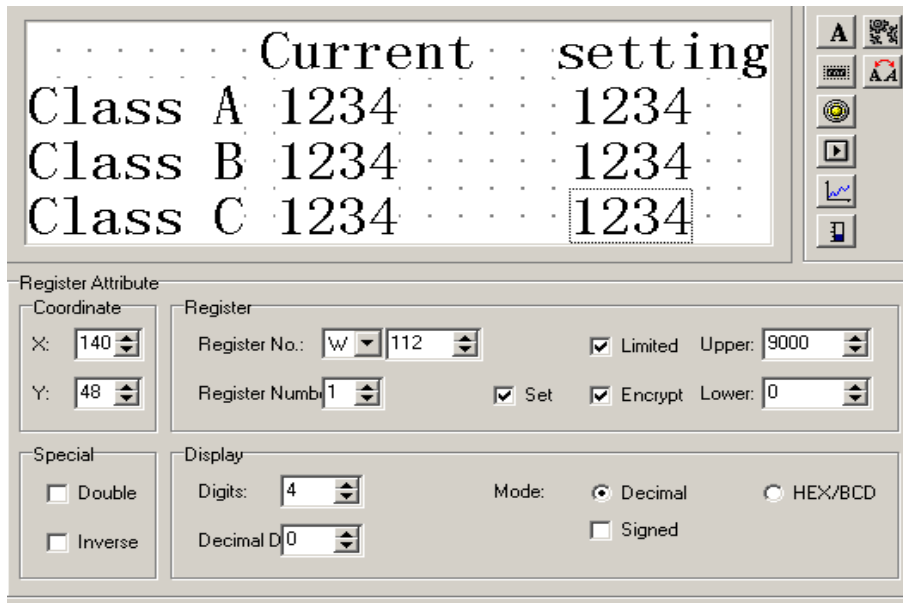

Note: The order of the three data set windows being edited (i.e. mouse's click order) is the same with the order set when operating in practice. If click three data set elements from top to the bottom before saving a project, when running, first set the production of class A, then class B, the last class C.

## 2-2-8 Indicate lamps

The following, we will tell how to make a mode set screen. At the same time, we will also tell how to set indicate lamps and function keys in details.

E.g. The function of No.20 screen is to select the machine's work mode. Manual/automatic: In the manual mode, control the machine to roll ahead or back directly via the buttons on the panel. At the same time, the indicate lamp will show the motor's run status. The correspond relationship of the middle relay inside PLC is the following:

The status of the middle relay	The content of action
M10 = 1	Automatic mode
M10 = 0	Manual mode
M20 = 1	Motor run ahead
M21 = 1	Motor run back
M20 = 0 , M21 = 0	Motor stop running

---

The graphic steps are the following:

Click the [new] button, there will pop out a dialog box of “New Screen”. Set the screen’s No. to be 20, input “set mode” in the description.

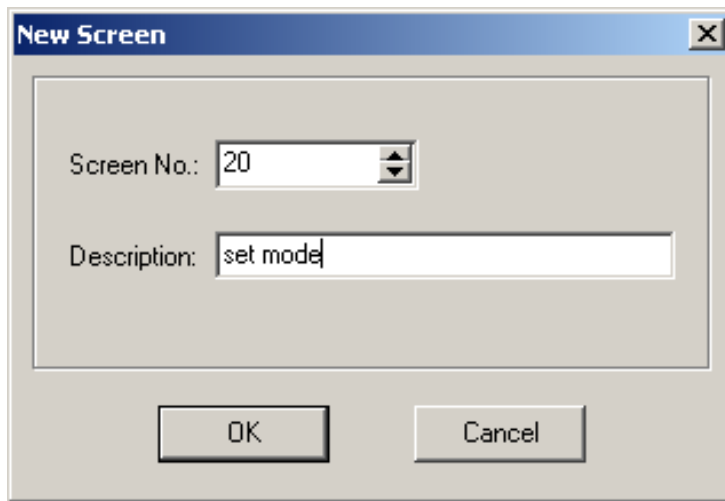

Click [OK] button to confirm. Then there will be the screen’s property content displays in the bottom of the interface. Set the previous screen No. to be 0 and the next screens No. to be 10. In the running status, press “^” to directly enter the menu screen, press “v” key to enter parameter setting screen.

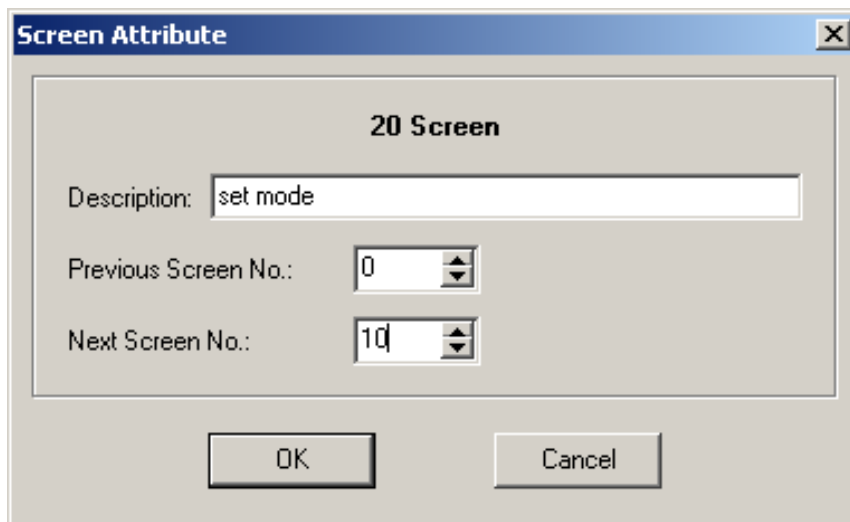

Click  button to place the indicate lamp, there will be a rectangle dashed frame moves with the mouse. When move to a proper position, click the left key of the mouse to confirm.

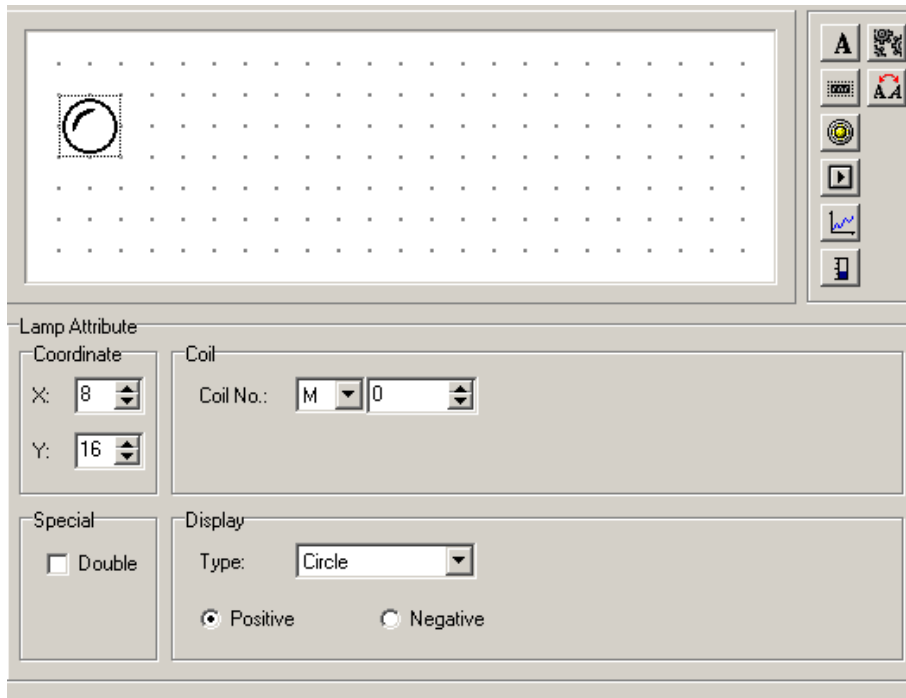

➤ Coin No.

The define ID No. of the middle relay inside the PLC correspond with the indicate lamp.

➤ Type

The shape of the indicate lamp, include square and circle.

➤ Positive

When the correspond middle relay is ON, the indicate lamp display in solid; when the correspond middle relay is OFF, the indicate lamp display in vacant.

➤ Negative

When the correspond middle relay is ON, the indicator lamp display in vacant; when the correspond middle relay is OFF, the indicate lamp display in solid.

Set the coil's No. to be M10, select the square indicate lamp; positive logic. Then in the window there will be a vacant square indicate lamp.

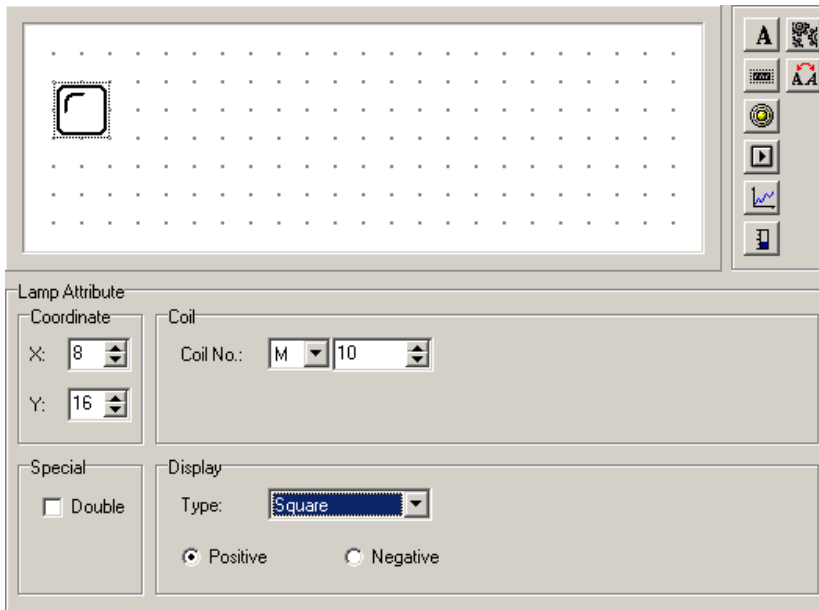

Click the  button to lay the function key, there will be a rectangle dashed frame which moves with the mouse, then move it to the proper position and click on the left key of mouse to confirm it.

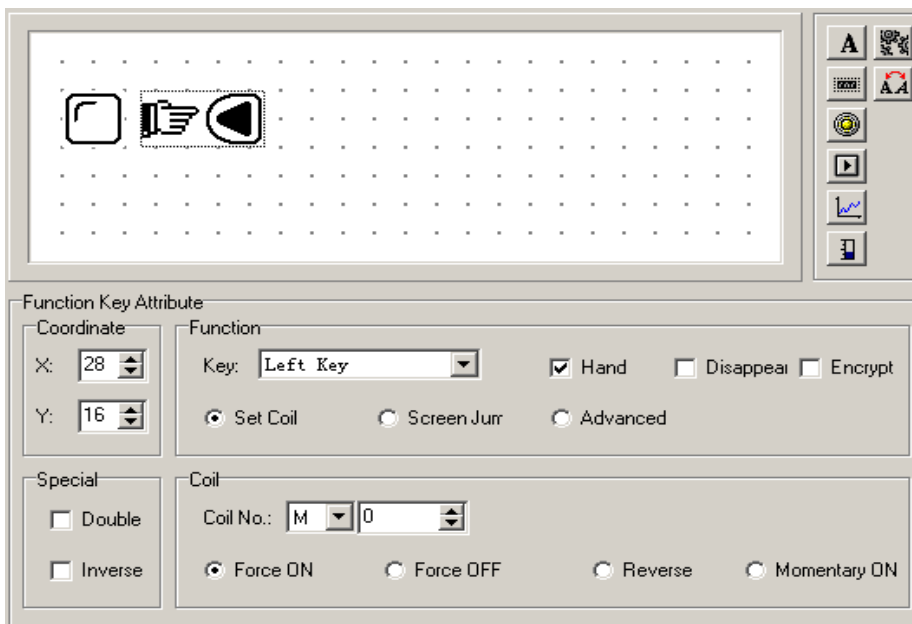

In the function column, select the "SET" button to be the auto mode setting button. Set the coil's define No. to be M10, and set the action mode to be ON. In order to display in brief, cancel the hand display.

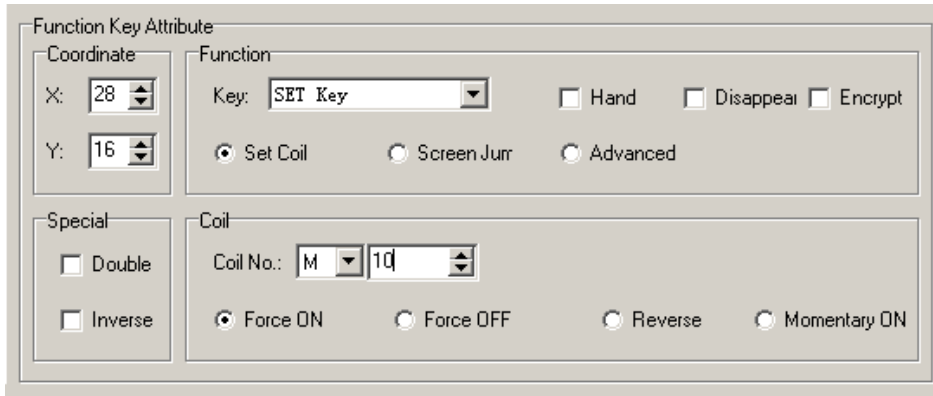

Place text “automatic” to the right of the button., it means that this button’s function is select automatic mode.

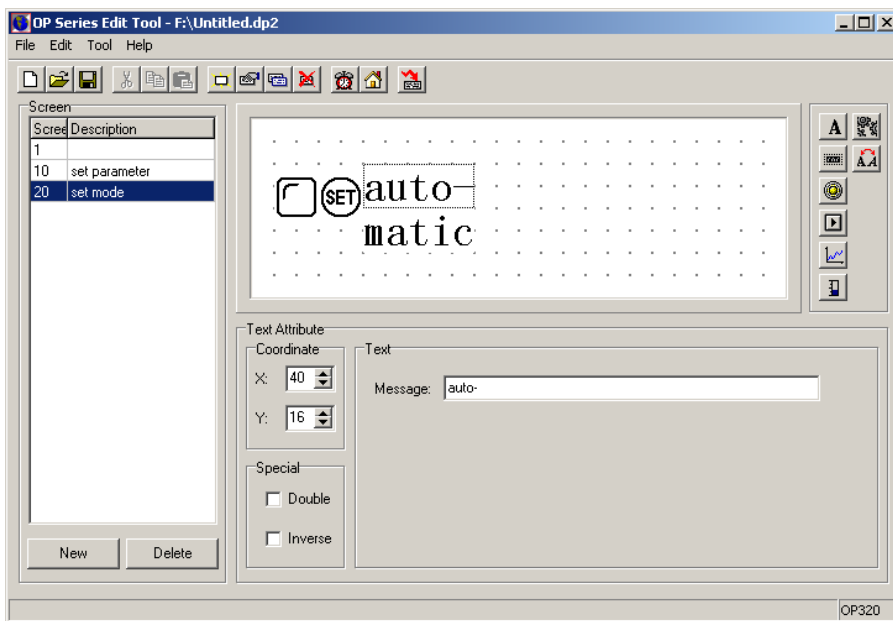

Set the manual button and the manual status indicate lamp with the same method. The address of the indicate lamp is still M10. Choose the display property negative logic. The appointed button is “ENT” button, the button’s function is set M10 relay OFF.

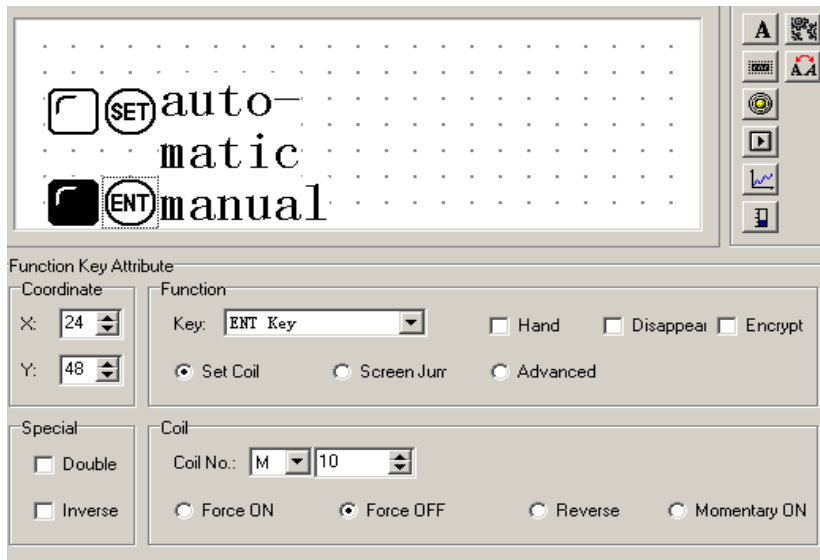

Set two circle indicate lamps, positive logic. Each one's address is M20 and M21, monitor the motor's work states. When the indicate lamp in the left lights, it means the motor is rolling ahead, when the indicate lamp in the right lights, it means the motor is rolling back.

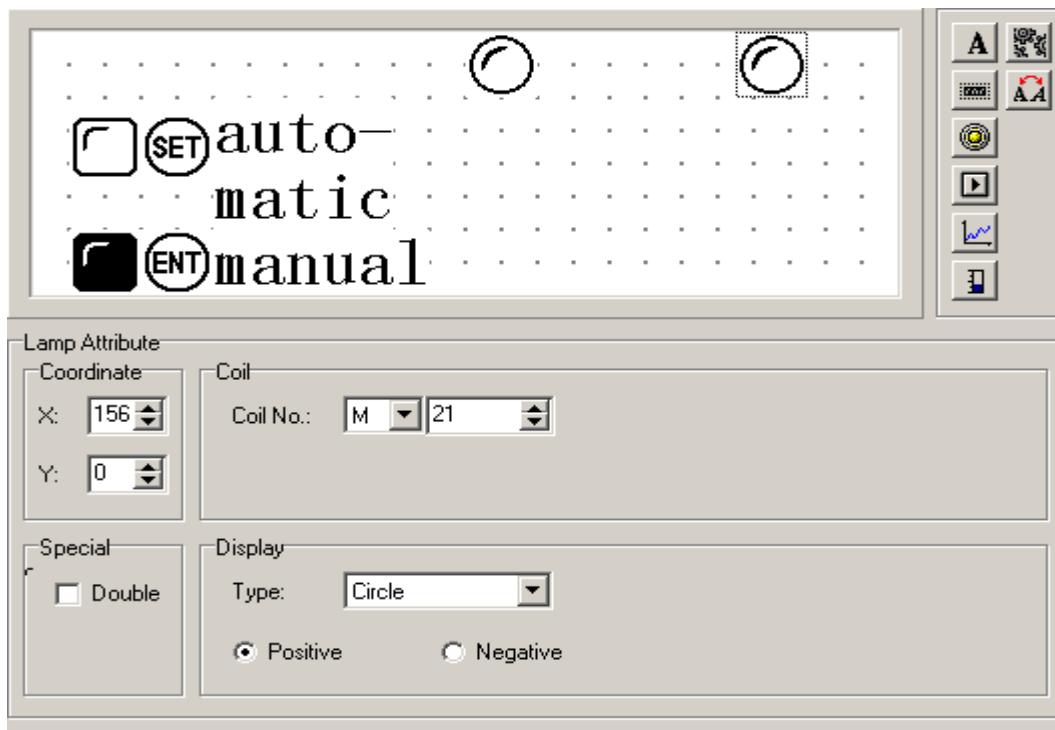



## 2-2-9 Function key (switch quantity operation)

Click  button to place the function key, select “>” button, the correspond address is M20, its function is momentary set M20 relay to be ON, and keep the hand graph. It indicates that when click on the “>” button, M20 of PLC is set to be ON, and the motor begins to roll ahead. (PLC program, use M20 to trigger Y0); when release the “>” button, M21 of PLC recovers to be OFF status, and the motor stop running ahead.

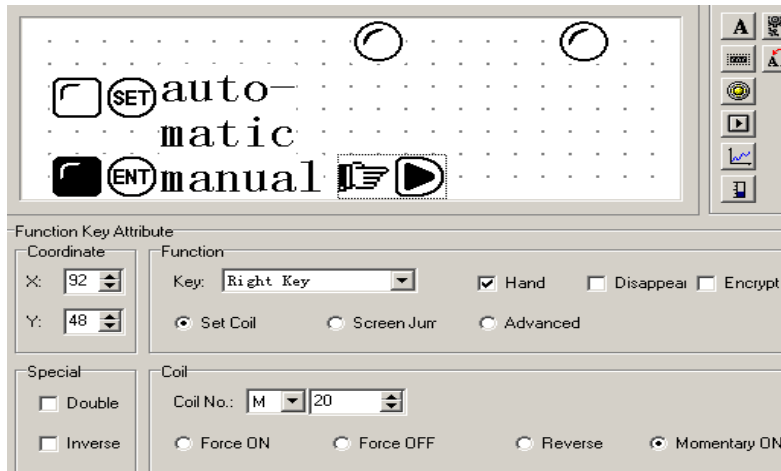

Click the  button to place the function key, select “<” button, its address corresponds with M21, its function is momentary set M21 relay to be ON, and keep the hand graph. It indicates that when click on the “<” button, M21 of PLC is set to be ON, and the motor begins to run back. (PLC program, use M21 to trigger Y0); when release the “>”, M21 recovers to the OFF status, and the motor stops running back.. At last place the text “run ahead” and “run back” to be the clue.

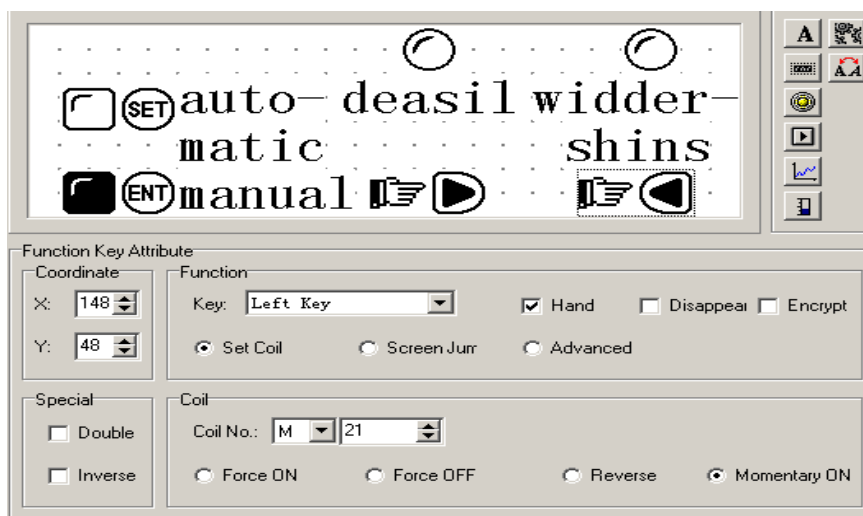

---

## 2-2-10 Fold-line graph

In the process of industry control, some parameters change slowly. The operator want to know these parameters' change process in a certain time. The fold-line graph should be the most ideal format.

Click the  button, there will be a rectangle dashed frame moving with the mouse. Move to the proper position and click the mouse's left key to confirm.

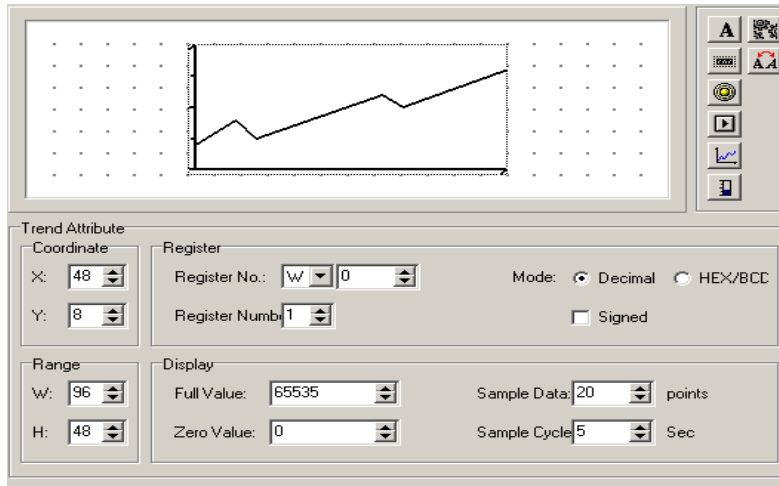

- Register No.

The correspond address correspond with the fold-line graph.

- Full value

When the fold-line graph displays in 100% scale, the value correspond with the register

- Zero value

When the fold-line graph displays in 0% scale, the value correspond with the register

- Sample data (the number of the dots)

The number of all the sampled dots from left to right. The larger the number, the more detailed the fold-line graph varies, of course the longer the time.

- Sample cycle

The interval time of every two sampled dots.

- Range

This value decides the length and the width of the fold-line graph.

Note: One fold-line graph element can only display one fold-line.

---

## 2-2-11 Bar graph

Bar graph is used to display analog quantity parameters intuitively, such as flow, pressure, water level etc. It's height, width and direction can be defined freely.

Click the  button, there will be a rectangle dashed frame moves with the mouse. Move to the proper position and click the left key of the mouse to confirm.

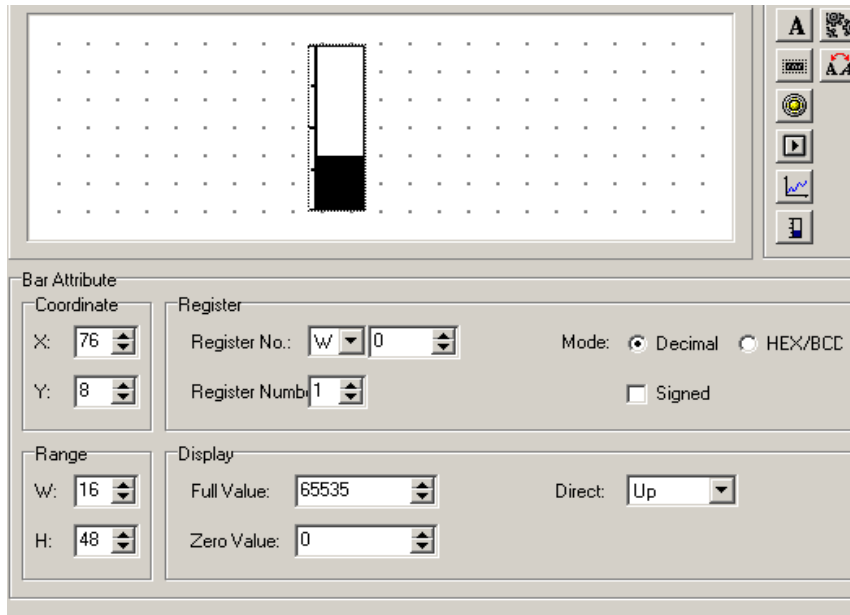

- Register No.

The register's address corresponds with the bar graph.

- Full value

When the bar graph displays in 100% scale, the value corresponds with the register.

- Zero value

When the bar graph displays in 0% scale, the value corresponds with the register.

- Direct

The display direction of the bar, it can be up, down or be left, right.

- Range

This value decides the length and the width of the bar.

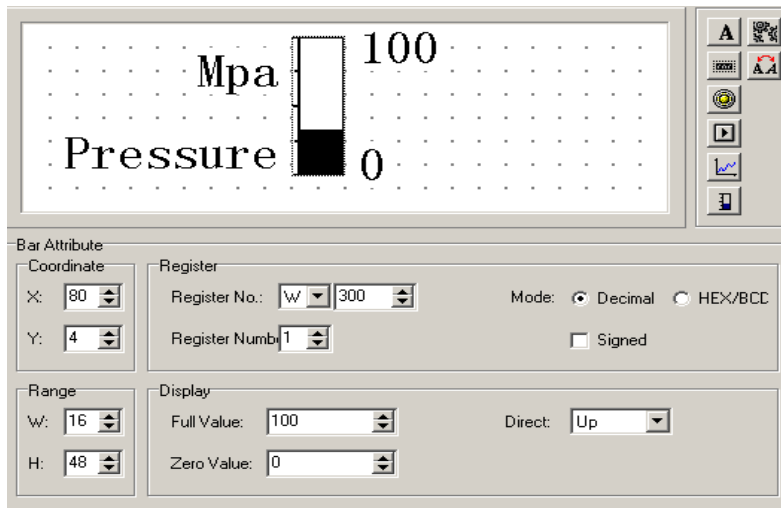

This bar monitors the value in D300. When the bar displays in the full scale, it indicates that the value in D100 is 100; when the bar displays in 50% scale, it indicates that the value in D300 is 50.

## 2-2-12 Graph display

Insert a bitmap file, which can display the machine's graph and make the operator easy to understand. Also it can display the factory's mark, badge, which can prompt the products' image.

Click the  button, there will be a search dialog box in the screen.

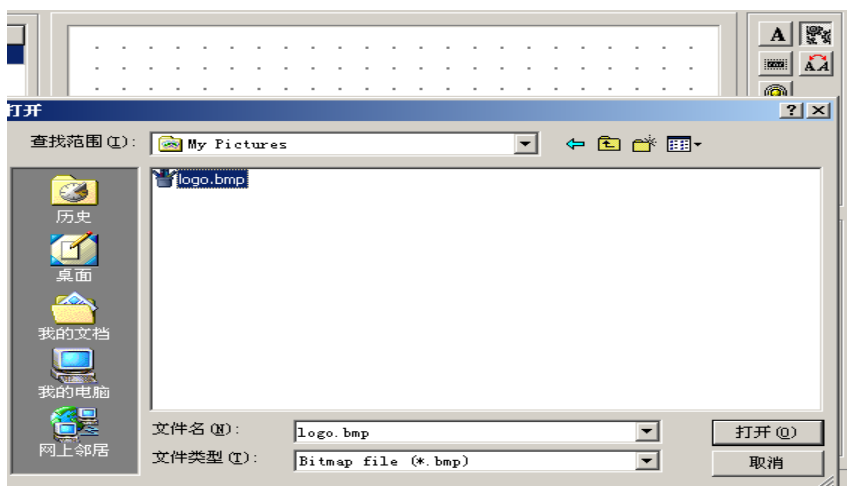

Select the bitmap file which intend to display, then double-click it or click on the open button, there will be a rectangle dashed frame moves with the mouse. Move to the proper position and click the mouse's left key to confirm.





Value	Content
0	the NO.1 motor whirls deasil
1	the NO.1 motor whirls widdershins
2	the NO.1 motor stops running

E.g. Input “No.1 motor rolls ahead” in the first line, input “No.1 motor rolls back” in the second line, input “No.1 motor stop” in the third line.

The dynamic message responds data in D200. If data in D200 hasn’t been set, then the text frame has no display, if data in D200 is 0, then display “No.1 motor clockwise”.

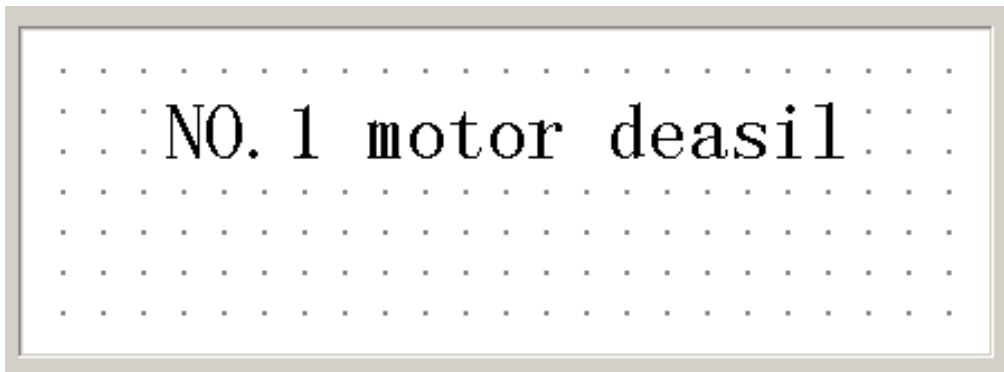

If data in D200 is 1, then display “No.1 motor wider shins”.

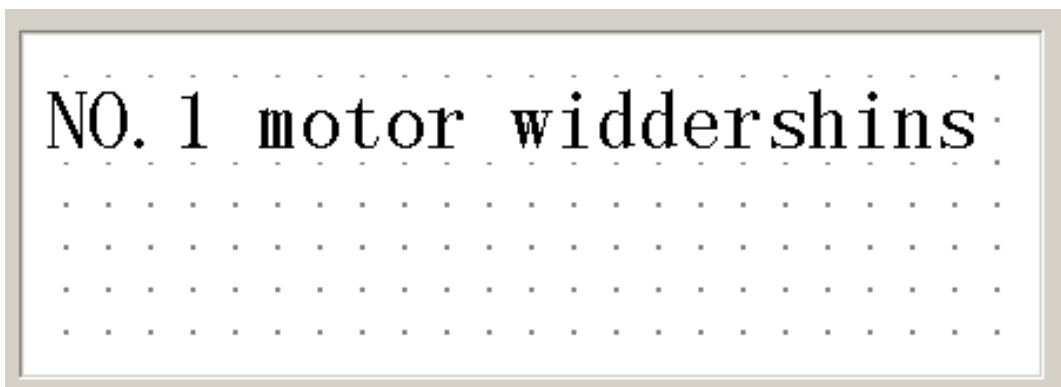

If data in D200 is 2, then display “No.1 motor stops running”.

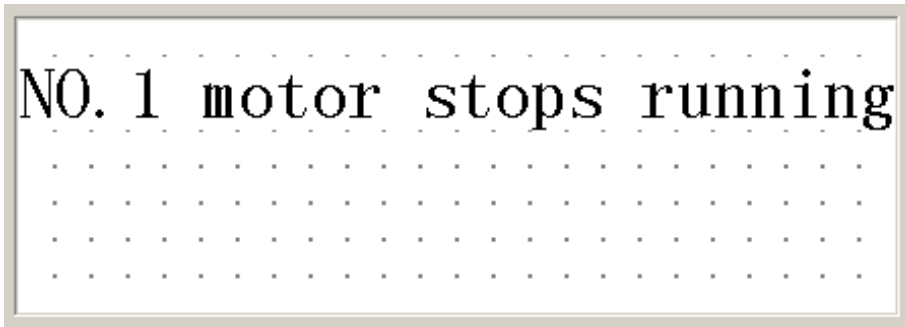

Note: the display space the text frame takes is the display space the text's longest content.

## 2-2-14 Alarm list

In the process of industry automation control, alarm display is very important and can be used in many situations. Alarm list is the most simple and direct format.

Each project of OP320 can set a group of alarm list information. A piece of alarm information corresponds with a middle relay. The definition No. is sequential. The middle relay's initial address can be set by the user according to the actual program. When any of the middle relay turns to ON from OFF, that means that when there is an alarm, OP320 will auto pop out the alarm display screen, then display the alarm information in the first line. When another middle relay be ON, display a new piece of alarm information in the second line. Conversely, after one alarm middle relay turns to OFF, the alarm information correspond to it will auto disappear. The login method is the following:

Click the  button, there will pop out an alarm list dialog box:

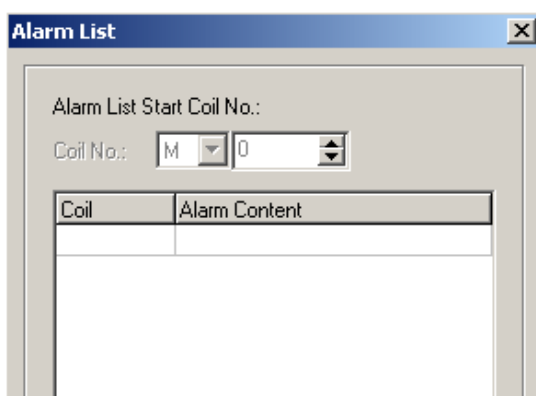

As there is no input content, the alarm list's content is vacant. First, move the cursor to the «alarm content» column, then write the alarm information “the temperature too high” into it. After confirming by entering the screen will display:



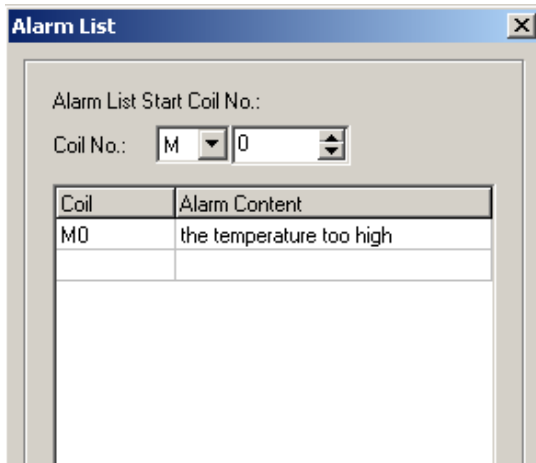

Input other information in the same way.

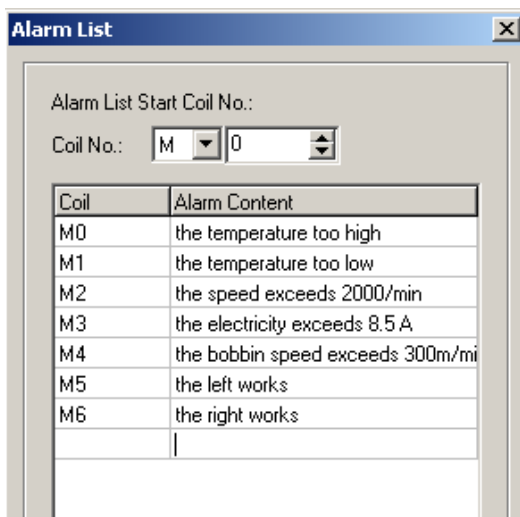

After all the alarm information been input, change the coin's No. to be M100 (example), i.e. it indicates that M100 to M106 individually corresponds with the 7 pieces of alarm information.

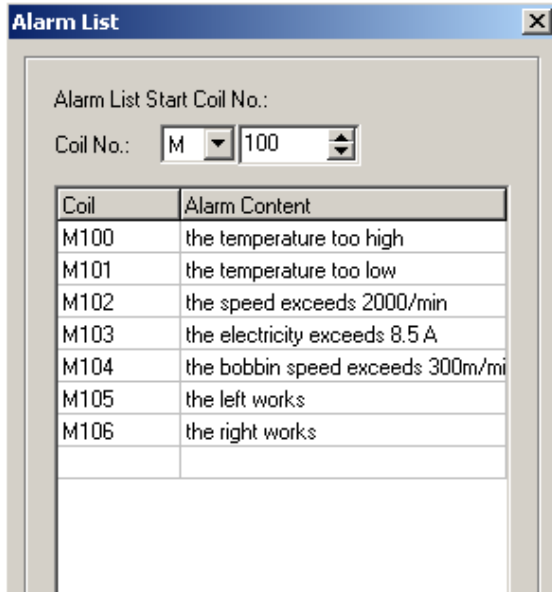

When OP320 works in normal, if M101, M102, M105 are set ON, then the display will auto pop out the alarm screen, and displays like that:

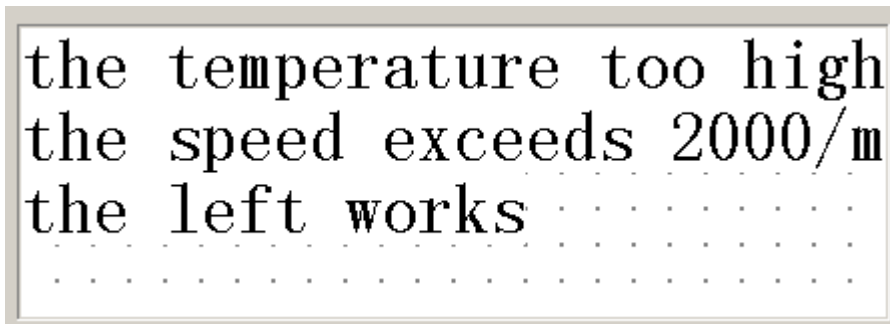

The operator can immediately do something to solve the problem. If you want to return back to the monitor screen, just click [] button.

## 2-3 Save a project

After finish the screen edition, you can save the project file, and download the screen project to OP20 , prepare for debugging.

Press  button, in the screen there will be a dialog box for you to save the project.

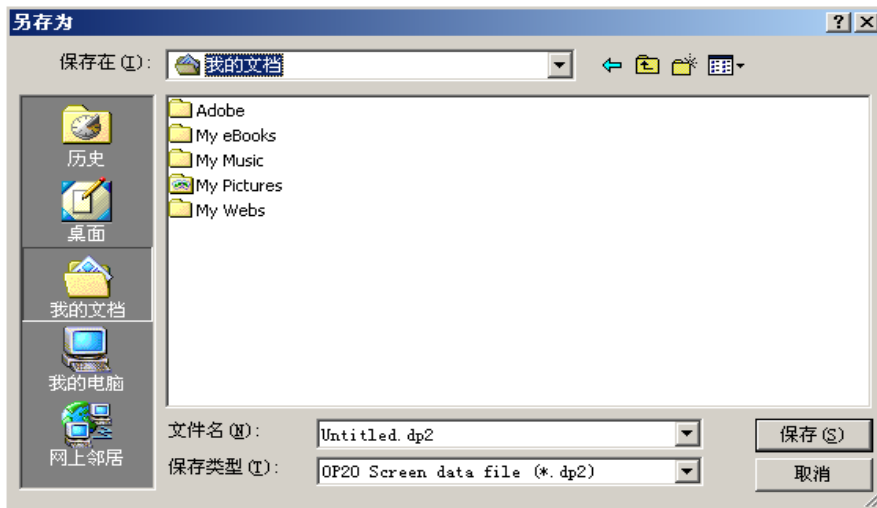

Select the correct path and file name to save it, and the file's extend name will auto be defined to be .dp2 .

Input the file name, select the right path, then press “save” button to save it.

## 2-4 Download the screen

Connect the computer's 9 pin RS232 port and the 9 pin port of OP320 with the communication download cable. Make sure that OP320 has been given the power. Click the

 button to begin downloading the data, there will be a reminder window to clue the download schedule.

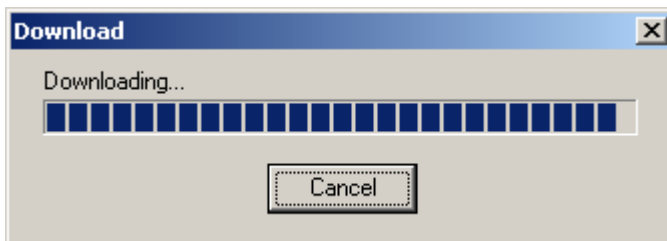

Note: In the process of downloading the screen's data, make sure that OP320 not drop the power

---

After finish transferring the screen, there will be a dialog box, it tells that all the screens have been transferred.

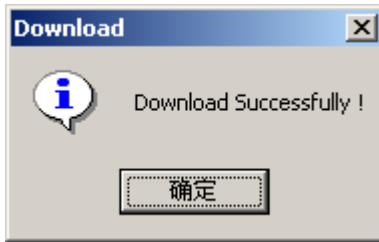

Turn off the display's power. Pull out the screen's transfer cable OP-SYS-CAB0, connect OP320 and PLC with the PLC communication cable.

Give PLC and the display the power, if communication is regular, you can then go on data monitor and other operation. If fail the communication because of communication parameter incorrect or wrong connection of cables, there will be "communicating" in the right bottom of the display, that means OP320 is communicating with PLC.

If the display cannot communicate with PLC all the time, please check the following items:

1. If the PLC type that the project chooses corresponds with that you actual connect.
2. If connect with the communication cable.
3. If the connection of the communication cables is right.
4. If the PLC communication parameter is correct or not.
5. If the PLC and the display has given power or not.
6. If you cannot find the problem, please connect with the supplier.

---

## Chapter 3 Operation methods of OP320

### 3-1 Online communication

After finish downloading the screen's data, cut the power supply and pull out the screen transfer cable OP-SYS-CAB0. Connect OP320 and PLC by cable for PLC communication port with PLC communication cable, check if the communication parameter is correct. Give power to PLC and OP320 at the same time. (OP320 uses DC24V.), then the display enters into the work status.

Note: no matter the PLC is in the status of running or programming, OP320 can operate normally.

### 3-2 Shift the screen

The following, we will take the project screen edited upward as the example to tell how to operate OP320.

OP320 will first displays the NO.1 screen. (Because the system's initial screen is No.1 screen.)

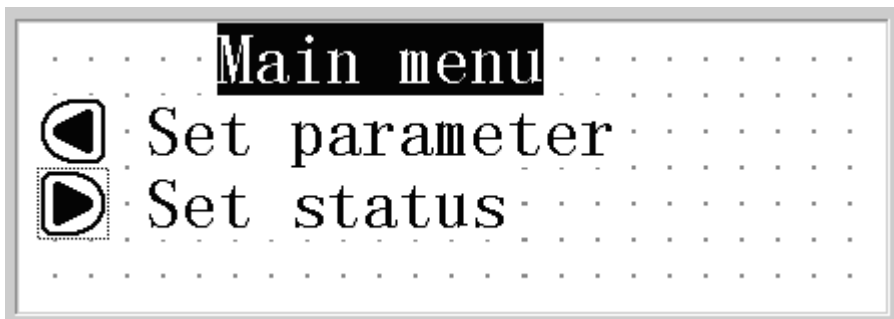

The No.1 screen is a menu screen, Shift directly to the sub screen via the function key. Press “<” key to directly enter the parameter set screen (No.10 screen).

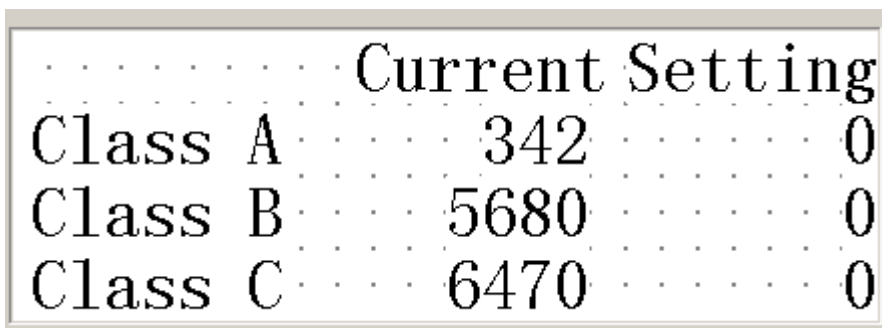

Current Setting			
Class A	342		0
Class B	5680		0
Class C	6470		0

Now, data in the left column displays the three classes' production each, corresponding with PLC's address: D100,D101,D102.

---

### 3-3 System's password

Before modifying the data, you should first open the system's password. Press the password jump key, the screen will display:

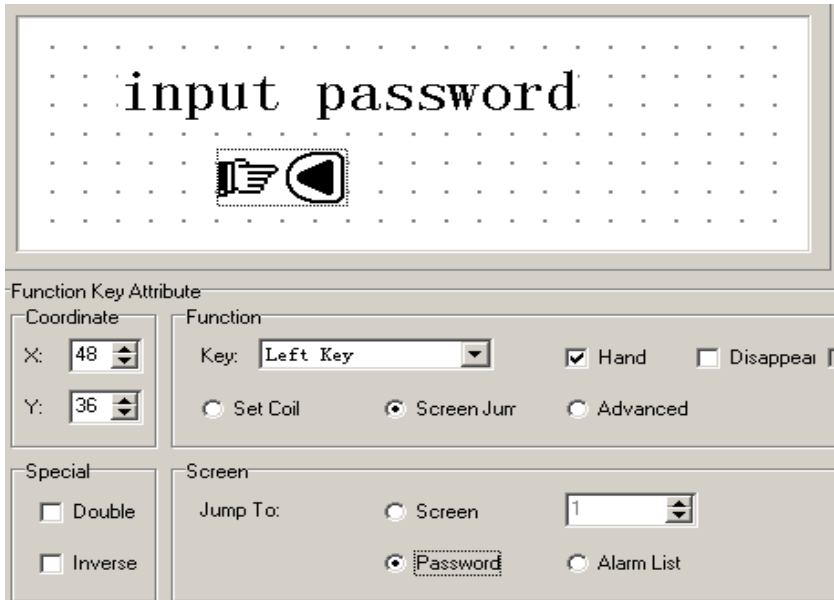

Click the  button to enter the password screen, the screen displays as the following:

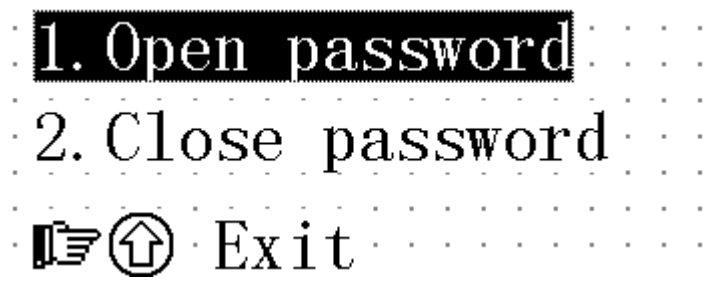

Select 1, execute the operation of opening password; select 2, make the system be in the status of password closing. Click on the  button, return back to the monitor status.

Select 1, the screen displays:

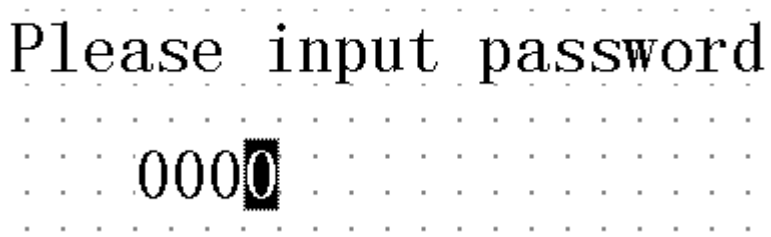

---

Click the “^” button or “√” button to input the password’s value, and click the “ENT” button to confirm.

If the password value is correct, the screen displays:

```
Password has been opened
Press any key . . . . .
to continue . . . . .
```

If the password value is error, the screen displays:

```
Password is error
Press any key . . . . .
to continue . . . . .
```

Select 2 , close the password, the screen displays:

```
Password has been closed
Press any key . . . . .
to continue . . . . .
```

### 3-4 Modify the data

If the password has been opened, click the “ENT” button. Production set value of class A will flick display, which means set class A’s production set value at first. Click the “^” button and “√” button to modify the value, click on the “<” and “>” to set the digit’s position, the data ranges from 0 to 9.

If confirm the input data, press the “ENT” button, after modifying the data will be written into PLC’s register D110. Then the production set values of Class A will stop blinking, the production set values of Class B will blink. It indicates that the production of class A has finished setting, start to set production of class B.

If cancel to set data or directly omit the setting of class A, continue to press “SET” key, class A’s production will display the original data, then the set value of class A’s production will stop glittering while class B’s production set value start to glitter.

After finish setting the production of Class C, all the data will display in normal, it indicates that you have exit the set status. If you want to enter set status again, click the “SET” button will be OK.

---

### 3-5 Switch value operating

After finish modifying the set value, click the “↑” button to return back to the system’s initial screen (the NO.1 screen.) the screen displays:

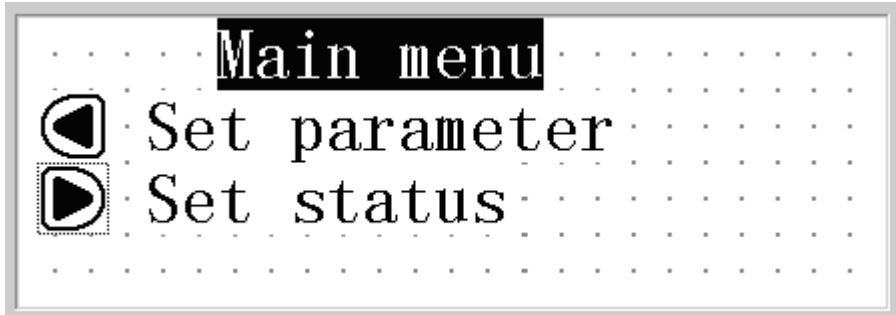

Click the “>” button to enter status set screen.

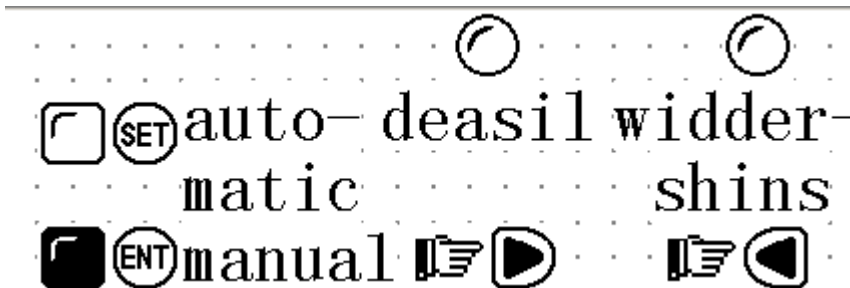

Now, the device is in the manual mode, click the “SET” button to set the device to be automatic mode, i.e. M10 of the PLC is set ON.

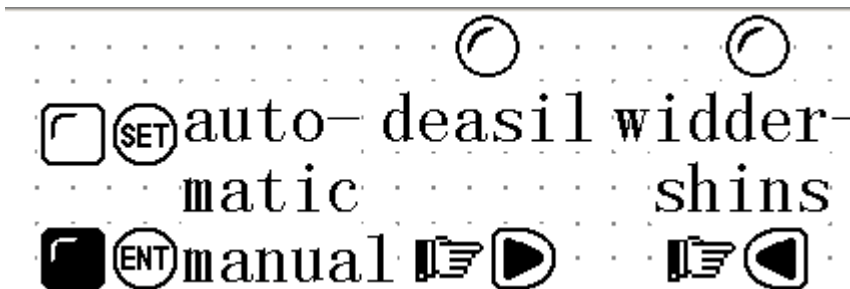



---

Click the “<” button and don’t release it, the motor will keep on rolling ahead, if click the “>” button and don’t release it, the motor will keep on rolling back.

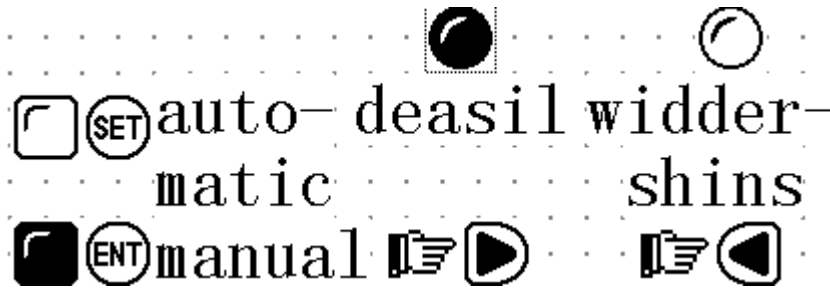

---

## Chapter 4 New addition function of OP520

### 4-1 Set general function key

General function key is the key that can be used by all the screens. It is only owned by OP520. After setting, the key's operation will be very clear. This will make the operation more easy, and even can compare with the touch panel.

When editing the project screen of OP520, press  key, there will be a dialog box for you to set the general function key.

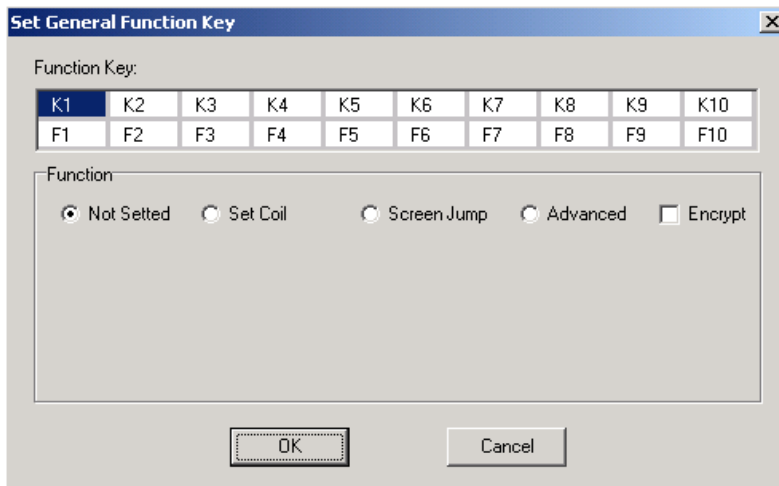

The dialog box displays 20 function keys (K1~K10,F1~F10), here what is displaying is the function's status of display's button  (the program is defaulted). We can see that each function key has 4 functions that can be set. The first three is single select function, which can choose only one function. Encrypt is multi-select function, it can be used with other function keys.

If the function key is not set, it means that this key can only be used as the normal function key. Only when the display's screen show this function key can it be effective to operate this key. After setting the global function key, the display will display any screen, operate this function will realize the same function.

#### 4-1-1 Set coil's function

In the "set the global function key" dialog box. Choose "set coil" for K1, the dialog box will display coil set option:

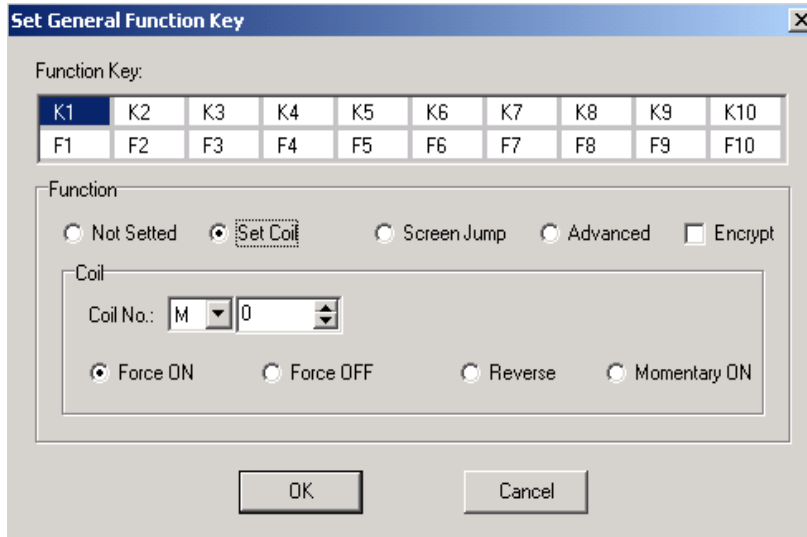

★ Force ON

When the key is pressed down, set the appointed middle relay to be ON.

★ Force OFF

When the key is pressed down, set the appointed middle relay to be OFF.

★ Reverse

When the key is pressed down, set the appointed middle relay in reverse.

★ Momentary ON

When the key is pressed down, set the appointed middle relay to be ON, when the key pops up, the appointed middle relay will be set OFF.

Set encryption

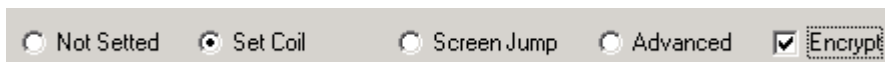

Choose encryption multi-select frame. Then the function key will have the function of password protection. Press down this button, there will be a password check screen.

---

## 4-1-2 Screen jump function

In the “Set General Function Key” dialog box, set function key K1 to make it have the function of screen jump. The dialog box will display screen jump choice:

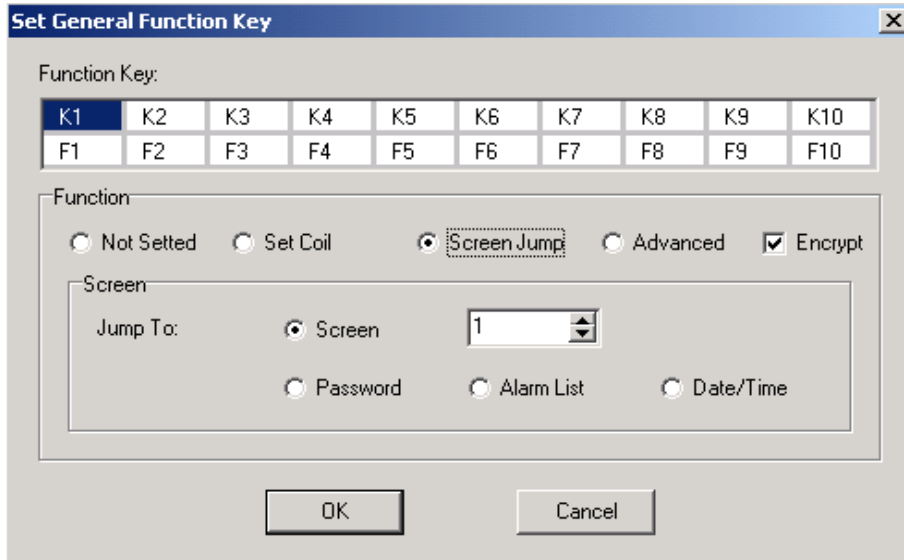

★ Screen

When press the key down, the screen will jump to one which use number in the number select frame as the screen No.

★ Password

When press the key down, the screen will jump to the password check screen.

★ Alarm list

When press the key down, the screen will jump to the alarm list screen

★ Date/time

When press the key down, the screen will jump to the Time/Date screen.

Set the encryption

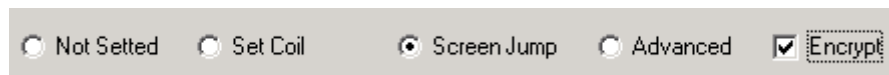

Choose the encryption check box, then the key will have the function of password protection. When press this function key down, there will come out a password check screen.

---

## 4-1-3 Advanced function

In the dialog box “ Set Global Function Key”, choose the advanced function for K1. The dialog box will display advanced function option:

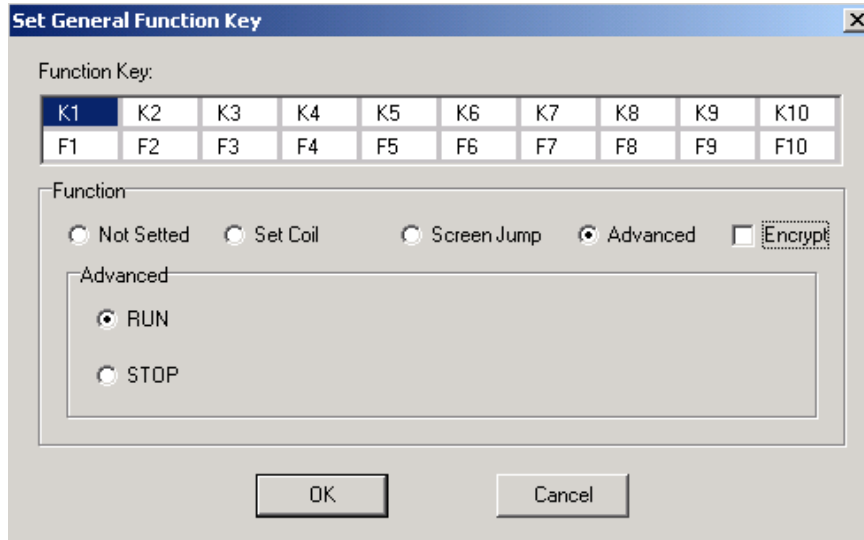

- ★ RUN  
When the key is pressed down, PLC will start to work.
- ★ STOP  
When the key is pressed down, PLC will stop to work.

Set the encryption:

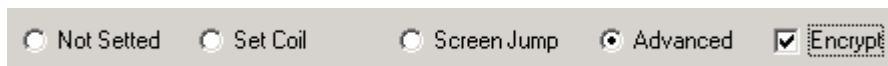

Choose the encryption check box, then this function key will have the function of password protection. When press the key down, there will come out a password check screen.

After finish setting the global function key, press [OK] button, then the set global function key will be saved (In this book we take K1 as the example, also we can set other global function key with the same method). After the screen been downloaded, when operate the display, press a global function key, it will realize a single function, and the function can be indicated by the card which can be pulled out. This will make the operator clear and easy to operate.

## 4-2 Status indicate lamp

There are 16 button indicate lamps in the left bottom of OP520, they can display according to the register's data, it will reflect the machine's work status.

Press the  key, open the system setting of OP series, there will come out a system setting dialog box:

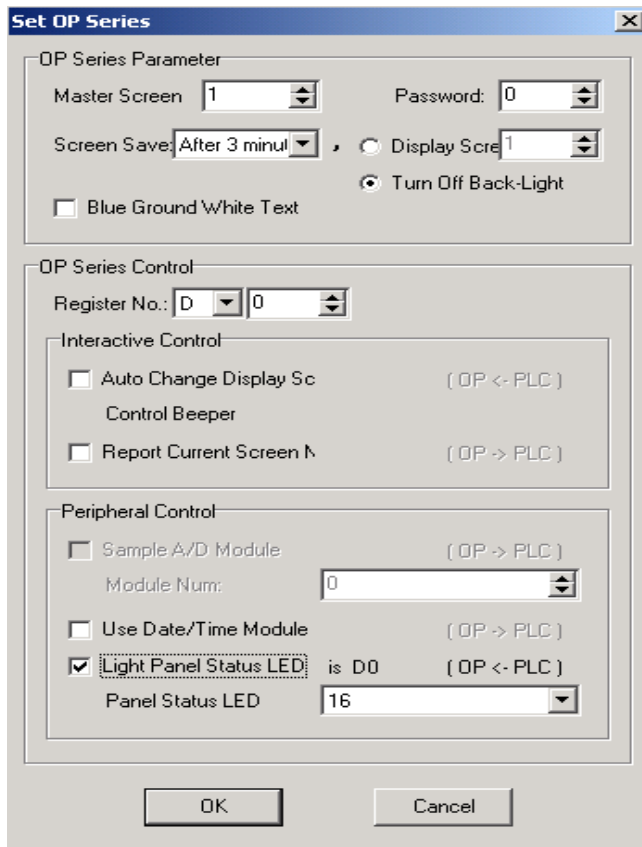

Choose the display function for the status indicate lamp. The 16 button indicate lamps are each controlled by Bit0-Bit10 of D0 register. Its correspond relationship is the following:

Bit7	Bit8	Bit5	Bit4	Bit3	Bit2	Bit1	Bit0
K1	F5	F6	F7	F8	F9	F10	K2

K3	K4	K5	K6	K7	K8	K9	K10
Bit15	Bit14	Bit13	Bit12	Bit11	Bit10	Bit9	Bit8

When Bit=1, the correspond indicate lamp will light, when Bit=0, the correspond indicate lamp will go out.

E.g. If you want to light [K1] indicate lamp, then Bit7=1, D0=H0080.

If you want to light [K3] indicate lamp, then Bit3=1, D0=H8000.

---

### 4-3 Application examples of global function key and button indicate lamp

The following, we will realize start/stop the motor with the global function key. Also use the panel indicate lamp to indicate ON/OFF status.

Create a new project, in the display choosing dialog box, choose OP520. Choose Mitsubishi in the PLC choosing dialog box, press  key, there will come out a dialog box for you to set the global function key:

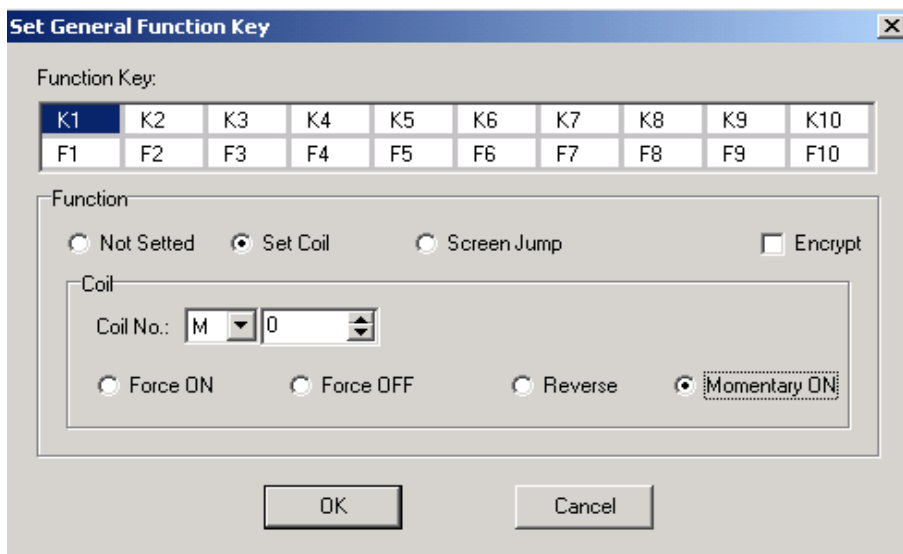

Set [K1] to make it the general function key, its function is set M0 momentary ON.

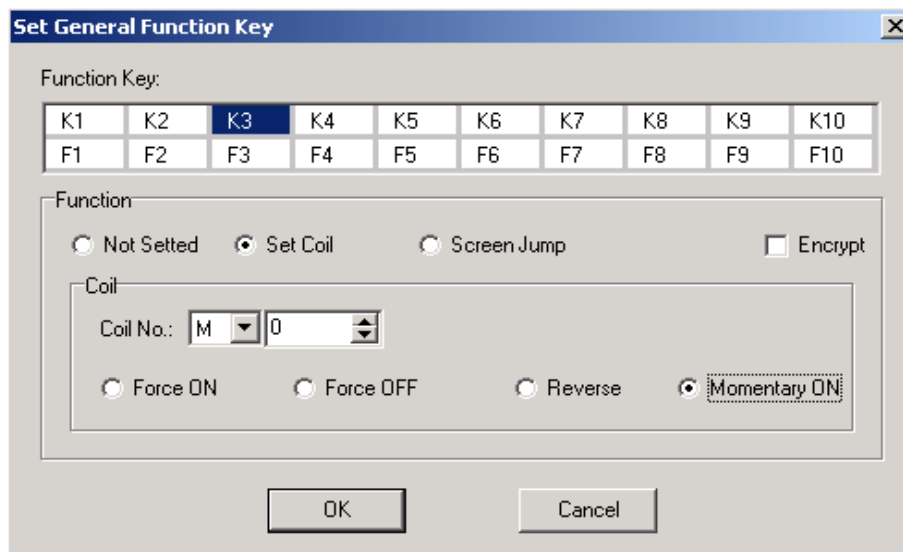

Set [K3] to make it the general function key, its function is set M1 momentary ON.

Set the correspond address for the indicate lamp, single click 《Tool bar》 menu:

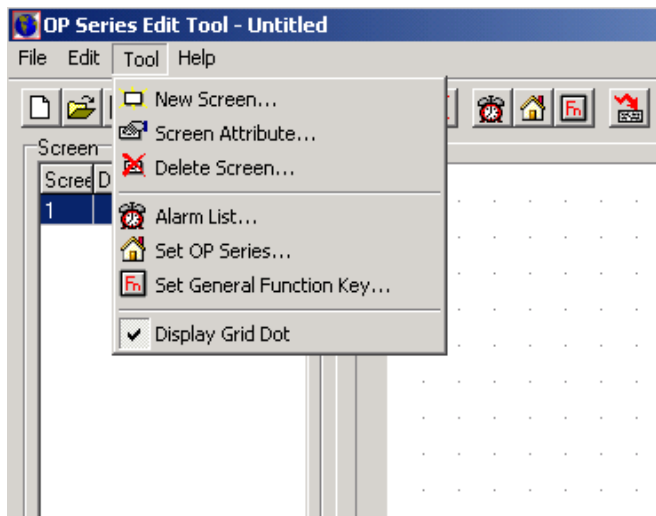

Single click 《Set OP Series》

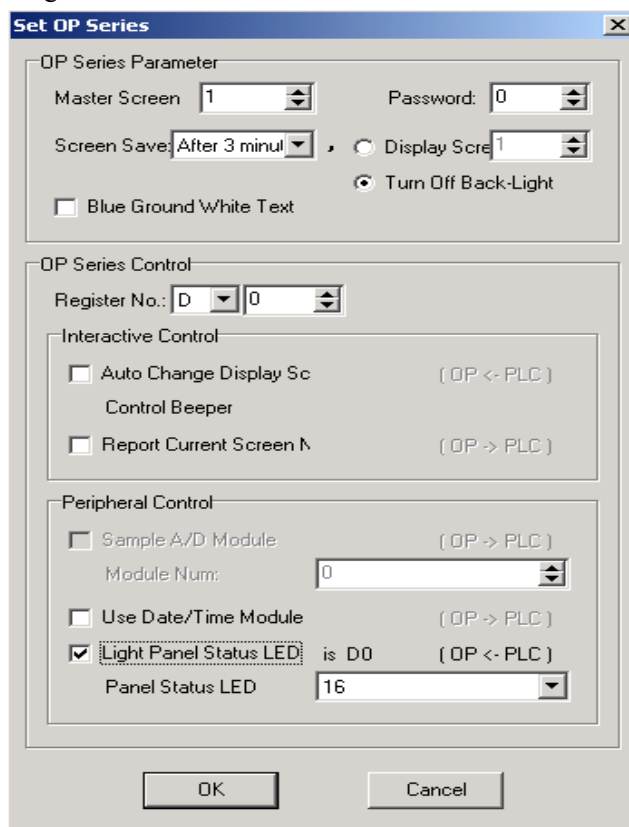

Choose 《Light Panel Status LED》 check box, the correspond word address of the 16 indicate lamps is D0.

Plc program the proper user program to realize the following action:

If M0=1 Then SET Y0 RST Y1 D0=H0080

If M1=1 Then RST Y0 SET Y1 D0=H8000



The following, we will make a function card, pull the cards below K1, K3 button, paste “start”, “stop” label on the cards.

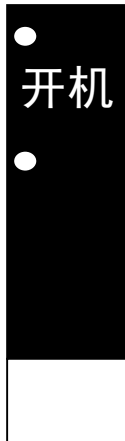

After finish making the cards, place them back.

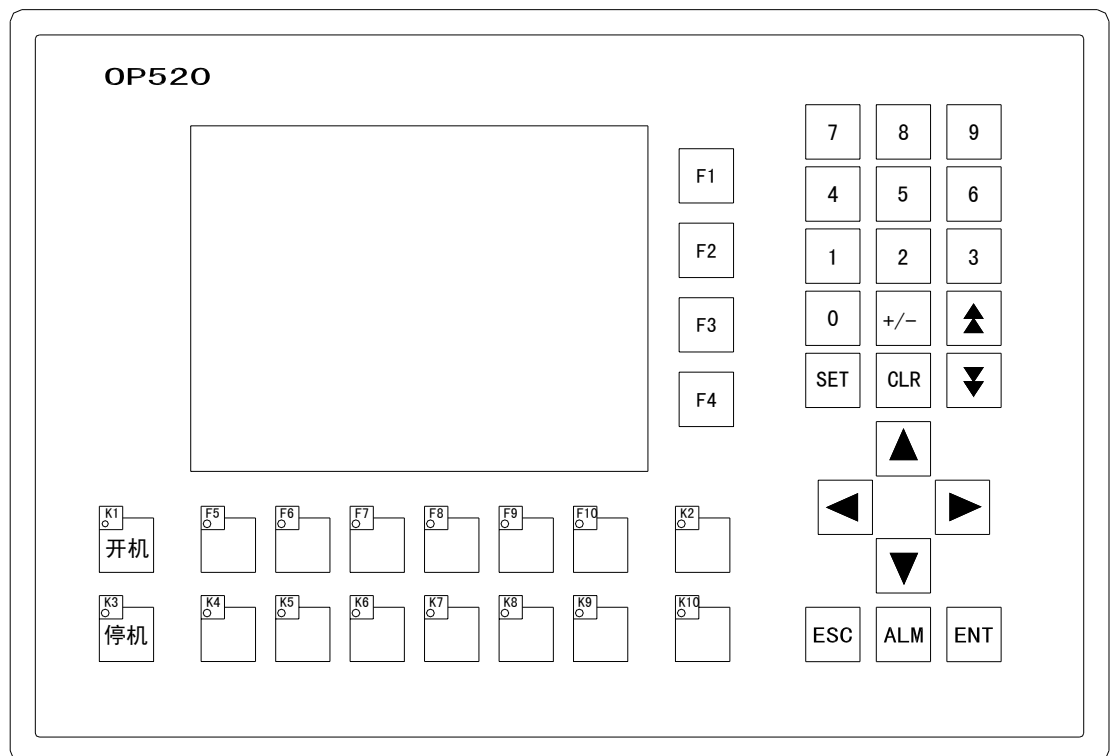

Connect PLC and OP520, then give them power and run, press [K1], Y0 output and the indicate lamp inside [K1] will light; press [K3] button, Y1 output and the indicate lamp inside [K3] will light.

---

## 4-4 inside clock (optional)

There is a clock inside OP520(optional), it can realize clock control.

Set the clock, click  button, or click “Tool” -> “Set OP Series” command, there will be a OP20 system parameter setting dialog box:

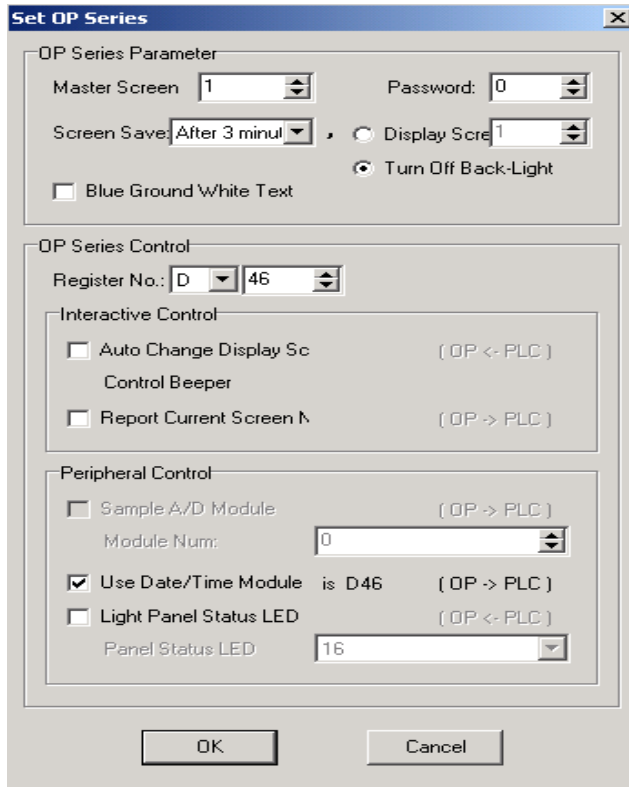

The image shows a screenshot of the "Set OP Series" dialog box. It is divided into three main sections: "OP Series Parameter", "OP Series Control", and "Peripheral Control".

- OP Series Parameter:** Includes "Master Screen" (set to 1), "Password" (set to 0), "Screen Saved" (set to "After 3 min"), "Display Sc" (set to 1), "Turn Off Back-Light" (checked), and "Blue Ground White Text" (unchecked).
- OP Series Control:** Includes "Register No.:" (set to D 46). Under "Interactive Control", there are checkboxes for "Auto Change Display Sc" (unchecked, labeled "( OP <- PLC )"), "Control Beeper", and "Report Current Screen N" (unchecked, labeled "( OP -> PLC )").
- Peripheral Control:** Includes "Sample A/D Module" (unchecked, labeled "( OP -> PLC )"), "Module Num:" (set to 0), "Use Date/Time Module" (checked, labeled "is D46 ( OP -> PLC )"), "Light Panel Status LED" (unchecked, labeled "( OP <- PLC )"), and "Panel Status LED" (set to 16).

At the bottom of the dialog box are "OK" and "Cancel" buttons.

Choose “Use Data/Time Module”, set the control register’s No. you use. E.g. set it to be D46, then the clock’s data will be placed into three groups of registers which start with D46. D46 will store of year and month, D47 will store data of date and hour, D48 will store data of minute and second.

After finish setting the clock, set a button with which we can enter the clock screen: Choose

any screen, press  key there will be a rectangle frame moves with the mouse in the screen, move to the proper position and click the mouse’s left key to confirm. Choose screen jump in the function dialog box, choose Date/Time in the screen dialog box:

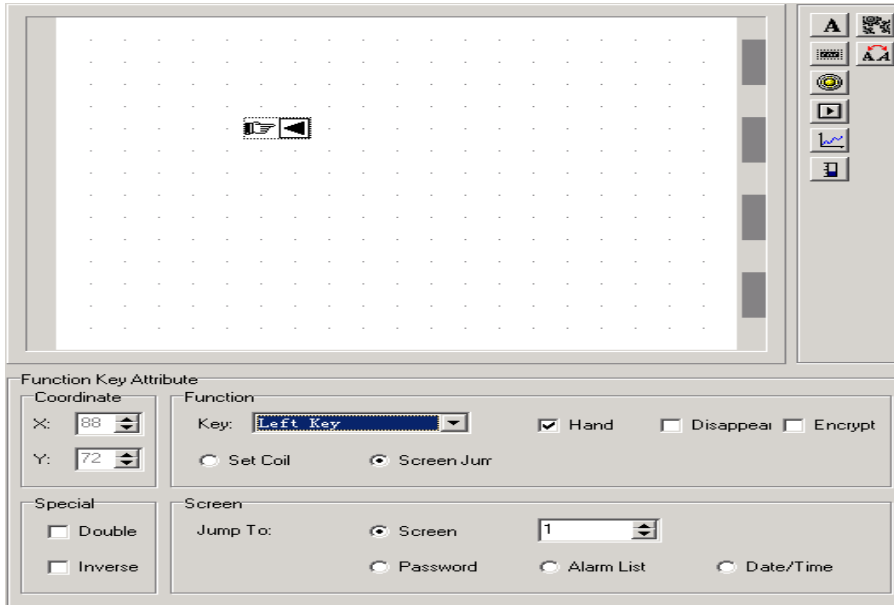

In order to indicate button's time function, we recommend the user to add "Time" presentation for distinguish.

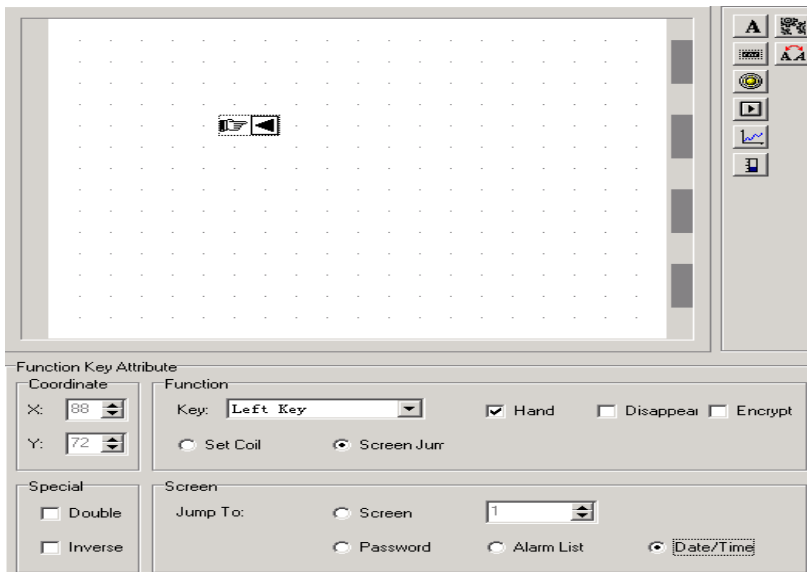

When operating OP520, press < key will enter Date/Time screen.

**2000 year 00 month 00 day**

**00 hour 00 minute 00 second**

There will be the screen (If OP520 appear 20FF year FF month FF Date FF Min. FF Sec. , it means that this OP520 has no clock module, only when the module has the clock can it display the clock), via setting to make the clock display the current time. Click SET key, the value to be set will glitter, modify in the order of year, month, day, hour, minute, second, press the number key( number key is not set for other function), press ENT to finish setting.

NOTE: Please don't set clock via modifying the register's value.

---

## Chapter 5 Application examples of OP520

### 5-1 Examples

The following, we will take our company's FC series PLC as the example to make a project. The project will carry on monitoring the pressure, flow, work time of two valves and material storages.

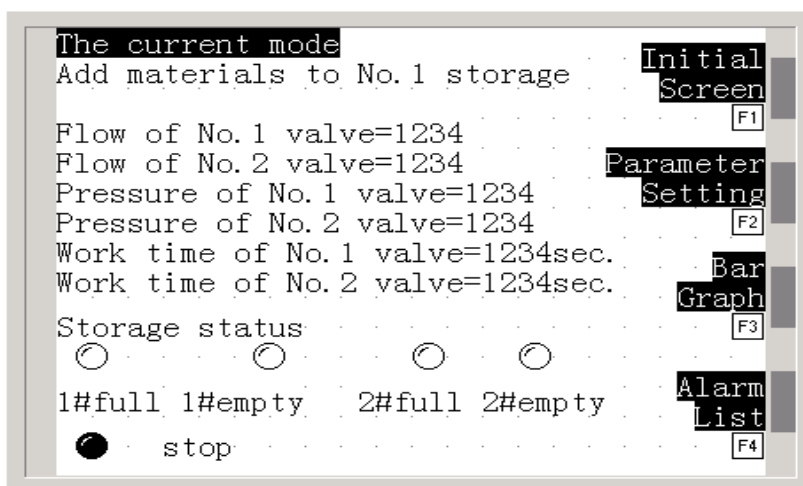
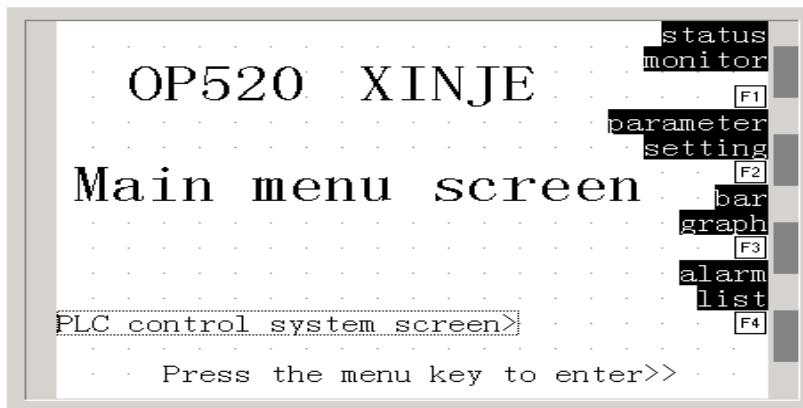

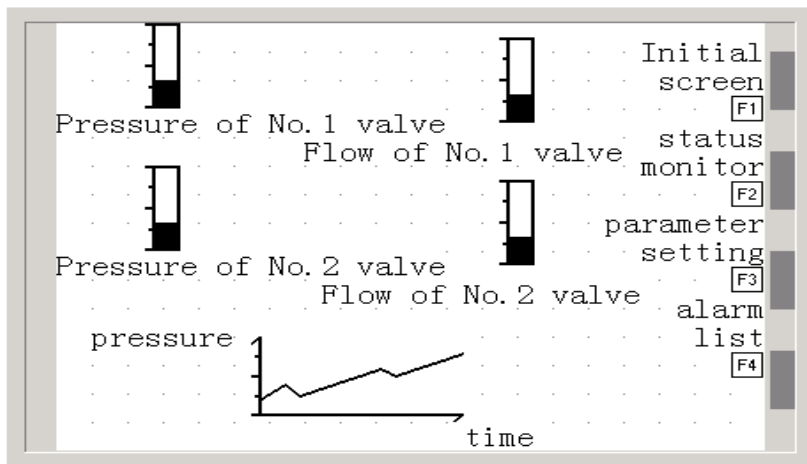
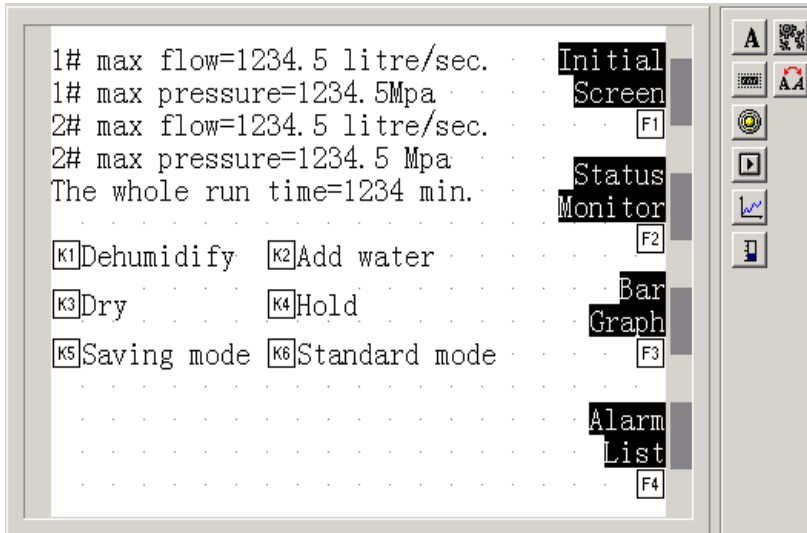

## 5-2 Analysis a project

The project is composed by the initial screen, parameter setting, status monitoring, bar graph, also set the alarm list. 4 function keys (F1~F4) is used to switch the screen, 6 function keys is used as special function keys. Establish four bar graph and a fold-line graph to monitor the pressure and flow of the valve. There are other data windows, indicate lamps

---

and words presentation.

Set No.1 screen as the main screen, the screen is the initial screen, display some basic information.

Create a new status monitor screen, set the screen's No. to be 10, the screen will display the statuses of the monitored object.

Create a new parameter setting screen, set the screen's No. to be 20, the screen is used to set parameters.

Create a new bar graph screen, set the screen's No. to be 30, the screen will display the monitored object's status in the form of graph.

Set the alarm list at last.

### 5-3 Make a screen

Open OP20 screen set tool, create a new project, there will come out a display choosing dialog box from the program. Choose OP520 and click OK.

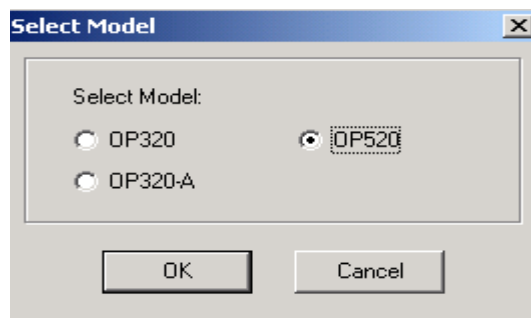

There will pop out a PLC choosing dialog box. In the pull down menu, choose xinje FC series and click OK. Then you can start screen edit.

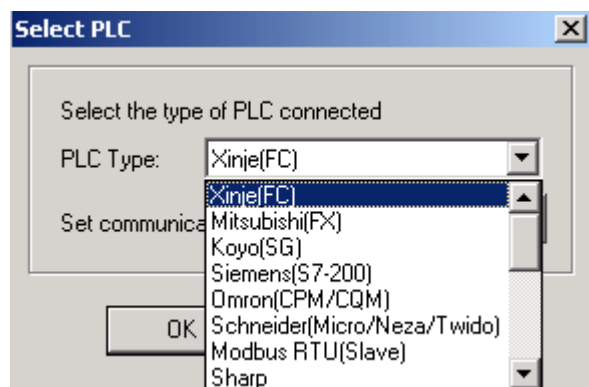

First, edit the main screen, here No.1 screen has exist (the program default it), choose No.1 screen to be the main screen. In the screen description text, fill in the main screen.

Screen Attribute

Description:

Previous Screen No.:

Next Screen No.:

Insert a graph: Press  button, Choose the LOGO graph that has been made and insert it in, place the graph to the proper position in the screen.

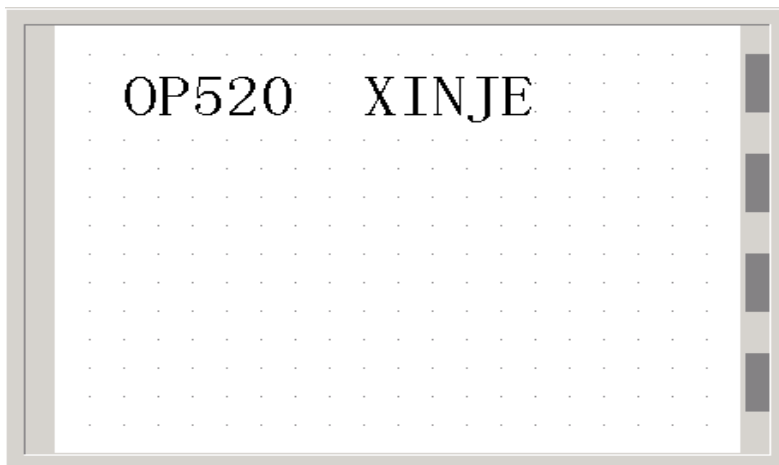

Input screen description words: Press  button, there will be a rectangle dashed frame moves with the mouse in the screen edit area, place it in the proper position.

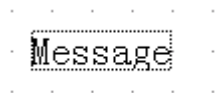

In the text input frame, change the defaulted "text" to be "main menu screen".

Text Attribute

Coordinate

X:

Y:

Special

Double

Inverse

Text

Message:

With the same method, input "PLC control system screen>", "Click menu key to enter>>", "status", "monitor", "parameter", "setting", "bar graph", "curve", "alarm" "list table" in the proper position.

Modify the text's property, choose the text "main menu screen", choose "multi-angle" property, in the property frame. The text "main menu screen" will turn to multi-angle

display.

Text Attribute

Coordinate

X: 88

Y: 40

Text

Message: Main menu screen

Special

Double

Inverse

Choose the text “status”, choose inverse phase property for the text property frame. The text bunch “status” will display in the format of inverse phase. Display the text bunch “monitor”, “parameter”, “setting”, “bar graph”, “curve”, “alarm”, “list” etc. in the format of inverse phase with the same method.

Place the function key F1. Press  key, there will be a rectangle dashed frame moves with the mouse in the screen edit area. Place it at the proper position. In its property frame, choose the key’s value as F1. Set it to be concealed. Choose screen jump function, the screen will jump to No.10 screen.

Function Key Attribute

Coordinate

X: 120

Y: 104

Function

Key: F1 Key

Hand  Disappea  Encrypt

Set Coil  Screen Jurr  Advanced

Special

Double

Inverse

Screen

Jump To:  Screen 10

Password  Alarm List  Date/Time

Place function key F2. Press  key to place the button at the proper position. In the property frame, choose the key’s value to be F2. Set it concealed. Set screen jump function, the screen will jump to No.20 screen.

Place function key F3. Press  key to place the button at the proper position. In the property frame, choose the key’s value to be F3. Set it concealed. Set screen jump function, the screen will jump to No.30 screen.

Place function key F4. Press  key to place the button at the proper position. In the property frame, choose the key’s value to be F4. Set it concealed. Set screen jump function, the screen will jump to the alarm list.

Main menu screen finish editing.



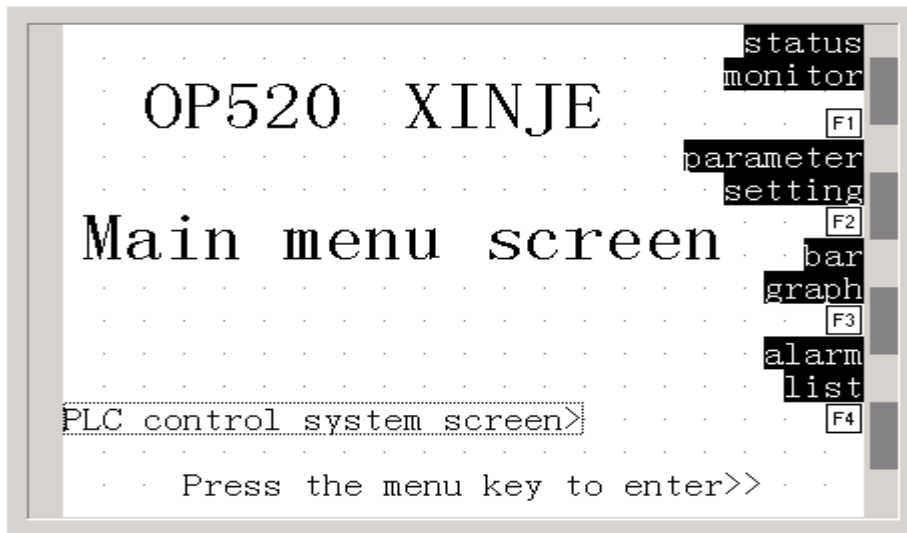

Now edit the status monitor screen. Choose No.10 screen (if it does not exist, create a new one, press  key). Fill "Status monitor" in the screen description text box.

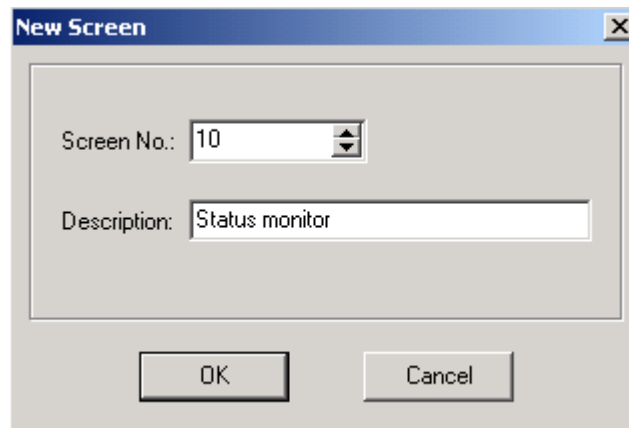

Input the screen description words: Press  key to place the text input frame. Change the defaulted words "message" to be "the current mode" in the text box. With the same method, at the proper position, input message "flow of No.1 valve=", "flow of No.2 valve=", "pressure of No.1 valve=", "pressure of No.2 valve=", "work time of No.1 valve", "work time of No.2 valve", "storage 1 is full", "storage 1 is empty", "storage 2 is full", "storage 2 is empty", "stop", "initialize" "screen", "parameter", "setting", "bar graph", "curve", "alarm", "list". Choose the message "the current mode", choose inverse phase in the text property box, the message "the current mode" will display in the format of inverse phase. With the same method to set "initialize" "screen", "parameter", "setting", "bar graph", "curve", "alarm", "list" to display inverse phase.

Place data window

Display the flow of No.1 valve. Press  key and there will be a rectangle dashed frame moves with the mouse in the screen edit area. Place it at the proper position and click the mouse's left key. In the data register property dialog box, modify the register's No. to be W100, modify the display digit to be 4 (the defaulted is 5), the data

window will display the flow of No.1 valve.

The image shows a 'Register Attribute' dialog box with the following settings:

- Coordinate:** X: 176, Y: 96
- Register:** Register No.: W100, Register Number: 1, Limited: , Upper: 0, Set: , Encrypt: , Lower: 0
- Special:** Double: , Inverse:
- Display:** Digits: 4, Mode:  Decimal,  HEX/BCD, Signed: , Decimal D: 0

Place the display window, display the flow of No.2 valve. Press  key and there will be a rectangle dashed frame moves with the mouse in the screen edit area. Place it at the proper position and click the mouse's left key. In the data register property dialog box, modify the register's No. to be W101, modify the display digit to be 4, the data window will display the flow of No.2 valve.

Place the display window, display the pressure of No.1 valve. Press  key and there will be a rectangle dashed frame moves with the mouse in the screen edit area. Place it at the proper position and click the mouse's left key. In the data register property dialog box, modify the register's No. to be W102, modify the display digit to be 4, the data display window will display the pressure of No.1 valve.

Place the display window, display the pressure of No.2 valve. Press  key and there will be a rectangle dashed frame moves with the mouse in the screen edit area. Place it at the proper position and click the mouse's left key. In the data register property dialog box, modify the register's No. to be W103, modify the display digit to be 4, the data display window will display the pressure of No.2 valve.

Place the display window, display the work time of No.1 valve. Press  key and there will be a rectangle dashed frame moves with the mouse in the screen edit area. Place it at the proper position and click the mouse's left key. In the data register property dialog box, modify the register's No. to be W104, modify the display digit to be 4, the data display window will display the work time of No.1 valve.

Place the display window, display the work time of No.2 valve. Press  key and there will be a rectangle dashed frame moves with the mouse in the screen edit area. Place it at

the proper position and click the mouse's left key. In the data register property dialog box, modify the register's No. to be W105, modify the display digit to be 4, the data display window will display the work time of No.2 valve.

Place the alterable text

Describe the current work status, press  key, there will be a rectangle dashed frame moves with the mouse, place the alterable text in the proper position. Set the register's ID to be W130, please note that the register is in the dynamic text property dialog box. When the value is 0, display "No.1 storage adds material"; when the value is 1, display "No.1 storage heat up and mix"; when the value is 2, display "No.2 storage adds material"; when the value is 3, display "No.2 storage heat up and mix"; when the value is 4, display "No.2 storage unload the material".

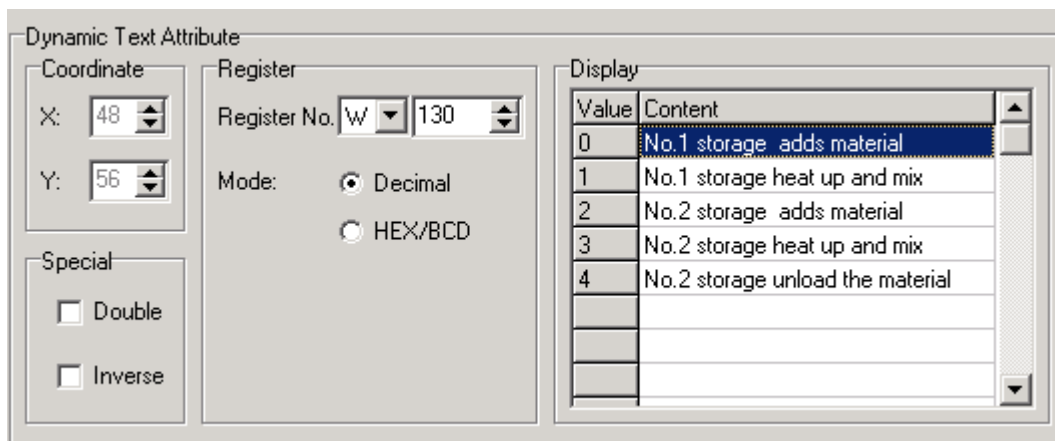



Value	Content
0	No.1 storage adds material
1	No.1 storage heat up and mix
2	No.2 storage adds material
3	No.2 storage heat up and mix
4	No.2 storage unload the material

Place the indicate lamp

Place "No.1 storage full" indicate lamp, press  key, there will be a rectangle dashed frame moves with the mouse, place it in the proper position. In the indicate lamp property dialog box, modify the coil's ID to be M10, the indicate lamp will display the status of No.1 storage (M10). When the indicate lamp change from hollow to solid (positive logic), it means that No.1 storage is full.

Lamp Attribute	
Coordinate X: <input type="text" value="144"/> Y: <input type="text" value="120"/>	Coil Coil No.: <input type="text" value="M"/> <input type="text" value="10"/>
Special <input type="checkbox"/> Double	Display Type: <input type="text" value="Circle"/> <input checked="" type="radio"/> Positive <input type="radio"/> Negative

Place “No.1 storage hollow” indicate lamp, press  key, there will be a rectangle dashed frame moves with the mouse, place it in the proper position. In the indicate lamp property dialog box, modify the coil’s ID to be M11, the indicate lamp will display the status of No.1 storage (M11). When the indicate lamp change from hollow to solid (positive logic), it means that No.1 storage is hollow.

Place “No.2 storage full” indicate lamp, press  key, there will be a rectangle dashed frame moves with the mouse, place it in the proper position. In the indicate lamp property dialog box, modify the coil’s ID to be M12, the indicate lamp will display the status of No.1 storage (M12). When the indicate lamp change from hollow to solid (positive logic), it means that No.2 storage is full.

Place “No.2 storage hollow” indicate lamp, press  key, there will be a rectangle dashed frame moves with the mouse, place it in the proper position. In the indicate lamp property dialog box, modify the coil’s ID to be M13, the indicate lamp will display the status of No.1 storage (M13). When the indicate lamp change from hollow to solid (positive logic), it means that No.2 storage is hollow.

Place “stop” indicate lamp, press  key, there will be a rectangle dashed frame moves with the mouse, place it in the proper position. In the indicate lamp property dialog box, modify the coil’s ID to be M14, the indicate lamp will display the status of stop(M14). When the indicate lamp change from solid to hollow (negative logic), it means stop.

Place the function key F1, press  key, there will be a rectangle dashed frame moves with the mouse, place it in the proper position. In the property dialog box, choose the key value as F1, set it concealed, choose screen jump function, the screen will jump to No.1 screen.

Function Key Attribute	
<b>Coordinate</b> X: <input type="text" value="40"/> Y: <input type="text" value="160"/>	<b>Function</b> Key: <input type="text" value="F1 Key"/> <input type="checkbox"/> Hand <input checked="" type="checkbox"/> Disappea <input type="checkbox"/> Encrypt <input type="radio"/> Set Coil <input checked="" type="radio"/> Screen Jurr <input type="radio"/> Advanced
<b>Special</b> <input type="checkbox"/> Double <input type="checkbox"/> Inverse	<b>Screen</b> Jump To: <input checked="" type="radio"/> Screen <input type="text" value="1"/> <input type="radio"/> Password <input type="radio"/> Alarm List <input type="radio"/> Date/Time

Place the function key F2, press  key, place it in the proper position. In the property dialog box, choose the key value as F2, set it concealed, choose screen jump function, the screen will jump to No.20 screen.

Place the function key F3, press  key, place it in the proper position. In the property dialog box, choose the key value as F3, set it concealed, choose screen jump function, the screen will jump to No.30 screen.

Place the function key F4, press  key, place it in the proper position. In the property dialog box, choose the key value as F4, set it concealed, choose screen jump function, the screen will jump to alarm list.

Finish editing the status display screen .

The current mode	Initial Screen
Add materials to No.1 storage	<input type="text" value="F1"/>
Flow of No.1 valve=1234	Parameter Setting
Flow of No.2 valve=1234	
Pressure of No.1 valve=1234	<input type="text" value="F2"/>
Pressure of No.2 valve=1234	
Work time of No.1 valve=1234sec.	Bar Graph
Work time of No.2 valve=1234sec.	
Storage status	<input type="text" value="F3"/>
<input type="radio"/> <input type="radio"/> <input type="radio"/> <input type="radio"/>	Alarm List
1#full 1#empty 2#full 2#empty	
<input checked="" type="radio"/> stop	<input type="text" value="F4"/>

---

Next, edit the parameter to set the screen, choose No.20 screen (if it does not exist, then create a new one, press  key). In the screen description box, fill in the parameter setting.

Input the screen description words: press  key to place the text input box. Modify the defaulted message “message” to be “the current mode”. With the same method, input message “The max flow of No.1 valve=”, “The max flow of No.2 valve=”, “The max pressure of No.1 valve=”, “The max pressure of No.2 valve=”, “the whole run time”, “parameter”, “setting”, “bar graph”, “curve”, “alarm”, “list”, choose “main menu screen”, choose multi-angle property, the message “main menu screen” will turn to multi-angle property. Choose the message “status”. Choose the inverse phase specification of the text box property. The message’s “status” will display inverse phase. With the same method, invert phase display “monitor”, “parameter”, “setting”, “bar graph”, “curve”, “list” etc.

Place the data window for No.1 valve’s max flow setting

Press  key, there will be a rectangle dashed frame moves with the mouse. Place it in the proper position. In the data register property dialog box, set the register’s ID as W200. Choose the set function, choose the max and mini limitation, set the max limitation as 30000, the mini limitation as 0. The data window will set No.1 valve’s max flow.

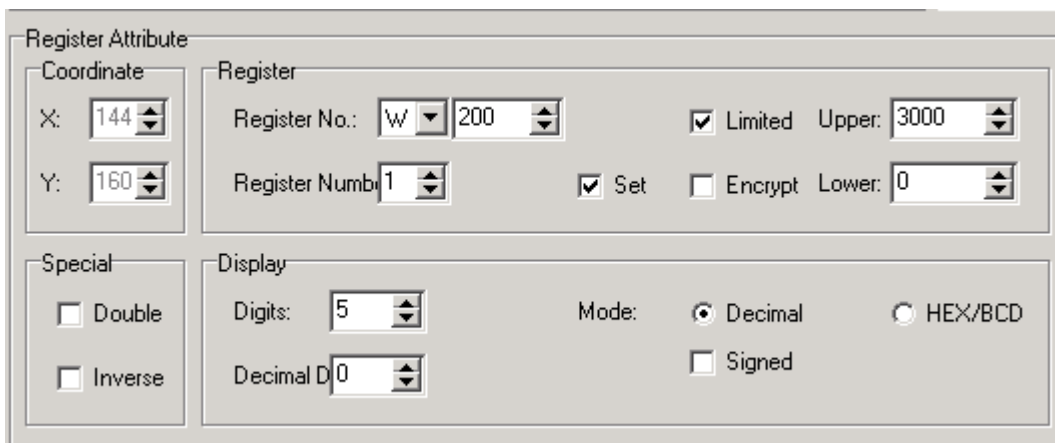

The image shows a 'Register Attribute' dialog box with the following fields and options:

- Coordinate:** X: 144, Y: 160
- Register:** Register No.: W 200, Register Number: 1
- Limitation:**  Limited, Upper: 3000,  Set,  Encrypt, Lower: 0
- Special:**  Double,  Inverse
- Display:** Digits: 5, Mode:  Decimal,  HEX/BCD,  Signed, Decimal D: 0

Place the data window for No.2 valve's max flow setting. Press  key, there will be a rectangle dashed frame moves with the mouse. Place it in the proper position. In the data register property dialog box, set the register's ID as W201. Choose the set function, choose the max and mini limitation, set the max limitation as 30000, the mini limitation as 0. The data window will set No.2 valve's max flow.

Place the data window for No.1 valve's max pressure setting. Press  key, there will be a rectangle dashed frame moves with the mouse. Place it in the proper position. In the data register property dialog box, set the register's ID as W202. Choose the set function, choose the max and mini limitation, set the max limitation as 30000, the mini limitation as 0. The data window will set No.1 valve's max pressure.

Place the data window for No.2 valve's max pressure setting. Press  key, there will be a rectangle dashed frame moves with the mouse. Place it in the proper position. In the data register property dialog box, set the register's ID as W203. Choose the set function, choose the max and mini limitation, set the max limitation as 30000, the mini limitation as 0. The data window will set No.2 valve's max pressure.

Place set coil function key

The function key will set dehumidify. Press  key, in the screen edit area, there will be a rectangle dashed frame moves with the mouse, put it in the proper position. In its property box, choose K1 for its key valve. Choose set coil function, set coil's ID as M100, set ON. It means when operate the display, set coil M100 ON when press down the function key.

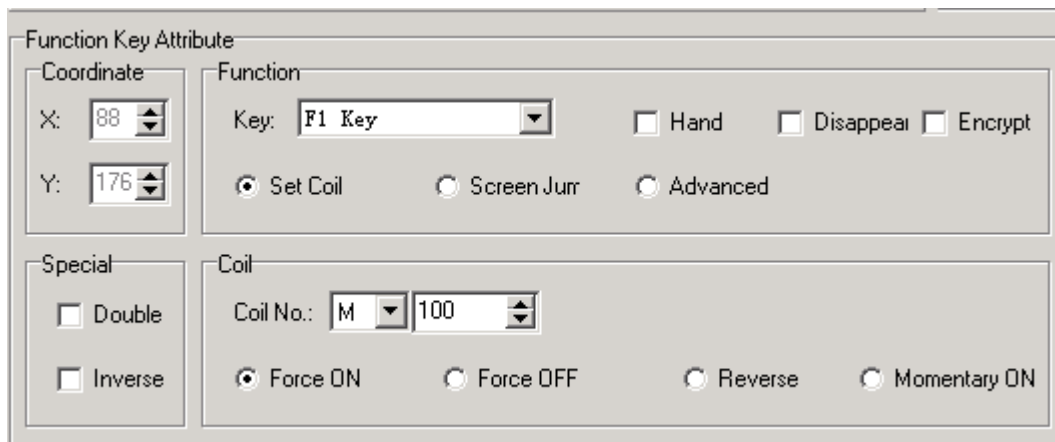

The image shows a 'Function Key Attribute' dialog box with the following settings:

- Coordinate:** X: 88, Y: 176
- Function:** Key: F1 Key,  Hand,  Disappear,  Encrypt
- Set Coil,  Screen Jurr,  Advanced
- Special:**  Double,  Inverse
- Coil:** Coil No.: M 100,  Force ON,  Force OFF,  Reverse,  Momentary ON

Set water set function key. Press  key, in the screen edit area, there will be a rectangle dashed frame moves with the mouse, put it in the proper position. In its property box,

---

choose K2 for its key valve. Choose set coil function, set coil's ID as M101, set ON. It means when operate the display, set coil M101 ON when press down the function key.

Set dry set function key. Press  key, in the screen edit area, there will be a rectangle dashed frame moves with the mouse, put it in the proper position. In its property box, choose K3 for its key valve. Choose set coil function, set coil's ID as M102, set ON. It means when operate the display, set coil M102 ON when press down the function key.

Set hold set function key. Press  key, in the screen edit area, there will be a rectangle dashed frame moves with the mouse, put it in the proper position. In its property box, choose K4 for its key valve. Choose set coil function, set coil's ID as M103, set ON. It means when operate the display, set coil M103 ON when press down the function key.

Set saving set function key. Press  key, in the screen edit area, there will be a rectangle dashed frame moves with the mouse, put it in the proper position. In its property box, choose K5 for its key valve. Choose set coil function, set coil's ID as M104, set ON. It means when operate the display, set coil M104 ON when press down the function key.

Set standard mode set function key. Press  key, in the screen edit area, there will be a rectangle dashed frame moves with the mouse, put it in the proper position. In its property box, choose K6 for its key valve. Choose set coil function, set coil's ID as M105, set ON. It means when operate the display, set coil M105 ON when press down the function key.

Place function key F1, press  key, in the screen edit area, there will be a rectangle dashed frame moves with the mouse, put it in the proper position. In its property box, choose the key value as F1, set it concealed. Choose screen jump function, the screen will jump to No.1 screen.

Place function key F2, press  key, put it in the proper position. In its property box, choose the key value as F2, set it concealed. Choose screen jump function, the screen will jump to No.10 screen.





Place function key F3, press  key, put it in the proper position. In its property box, choose the key value as F3, set it concealed. Choose screen jump function, the screen will jump to No.30 screen.

Place function key F4, press  key, put it in the proper position. In its property box, choose the key value as F4, set it concealed. Choose screen jump function, the screen will jump to alarm list.

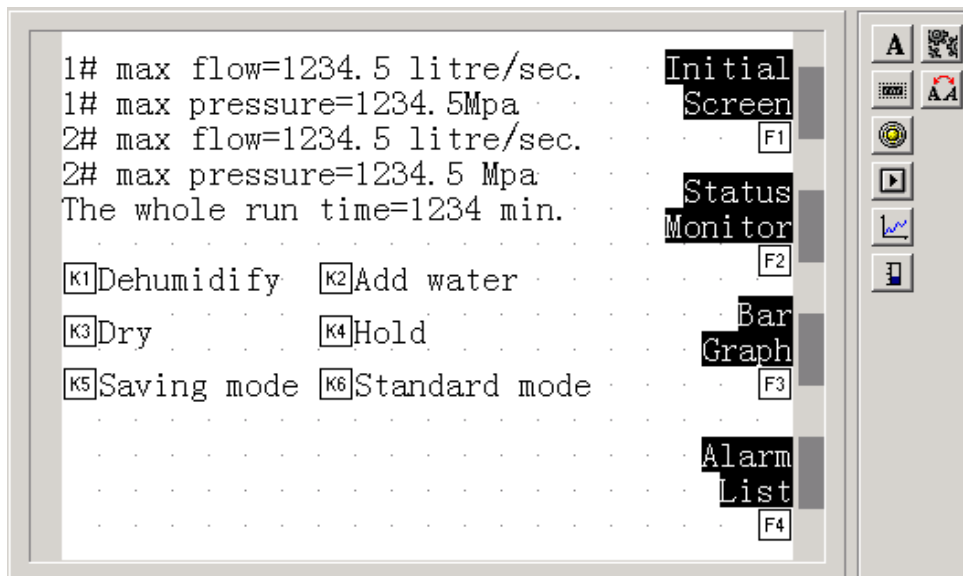
Finish editing screen's parameter setting.



At last, edit the bar curve screen, choose No.30 screen (If it does not exist, create a new one, press  key). In the screen description text box, fill in the bar curve.

Input screen description words: press  key; Place text input box, then change the defaulted "message" to "Time". In the proper position, input message "flow of No.1 valve", "flow of No.2 valve", "pressure", "Mpa", "Mpa", "liter/sec.", "liter/sec.", "status", "monitor", "parameter", "setting", "initialize", "screen", "alarm", "list". Select message "main menu screen", select multi-angle specification, the message "main menu screen" will display multi-angle. Select invert phase property, the message "status" will display inverse phase. With the same method, invert phase display "monitor", "parameter", "setting", "initialize", "screen", "alarm", "list" message.

Place bar graph

Real time display No.1 valve's pressure. Press  key, in the screen edit area, there will be a rectangle dashed frame moves with the mouse. Place it in

the proper position. In the bar graph property box, set register's ID W100. The full rated value is 1000, set width 26, set height 80. The bar graph will real time display No.1 valve's pressure.

The image shows a 'Bar Attribute' configuration dialog box with the following fields and settings:

- Coordinate:** X: 224, Y: 112
- Register:** Register No.: W 100, Register Number: 1, Mode:  Decimal,  HEX/BCC,  Signed
- Range:** W: 16, H: 48
- Display:** Full Value: 1000, Zero Value: 0, Direct: Up

Place bar graph, real time display No.1 valve's flow. Press  key, in the screen edit area, there will be a rectangle dashed frame moves with the mouse. Place it in the proper position. In the bar graph property box, set register's ID W101. The full rated value is 1000, set width 26, set height 80. The bar graph will real time display No.1 valve's flow.

Place bar graph, real time display No.2 valve's pressure. Press  key, in the screen edit area, there will be a rectangle dashed frame moves with the mouse. Place it in the proper position. In the bar graph property box, set register's ID W102. The full rated value is 1000, set width 26, set height 80. The bar graph will real time display No.2 valve's pressure.

Place bar graph, real time display No.2 valve's flow. Press  key, in the screen edit area, there will be a rectangle dashed frame moves with the mouse. Place it in the proper position. In the bar graph property box, set register's ID W103. The full rated value is 1000, set width 26, set height 80. The bar graph will real time display No.2 valve's flow.

Place curve graph. Press  key, in the screen edit area, there will be a rectangle dashed frame moves with the mouse. Place it in the proper position. In the bar graph property box, set register's ID W304. The full rated value is 32767 (defaulted). Data sample is 2 points, sample time space is 5 seconds. Set width 200, set height 80. The curve graph will real time

display the change of pressure.

Trend Attribute	
<b>Coordinate</b>	<b>Register</b>
X: 48	Register No.: W 304
Y: 88	Register Number: 1
	Mode: <input checked="" type="radio"/> Decimal <input type="radio"/> HEX/BCC
	<input type="checkbox"/> Signed
<b>Range</b>	<b>Display</b>
W: 96	Full Value: 32767
H: 48	Zero Value: 0
	Sample Data: 2 points
	Sample Cycle: 5 Sec

Place function key F1, press  key. In the screen edit area, there will be a rectangle dashed frame moves with the mouse. Place it in the proper position. In its property box, choose the key value as F1, set it concealed. Choose screen jump function, the screen will jump to No.1 screen.

Place function key F2, press  key. Place it in the proper position. In its property box, choose the key value as F2, set it concealed. Choose screen jump function, the screen will jump to No.10 screen.

Place function key F3, press  key. Place it in the proper position. In its property box, choose the key value as F3, set it concealed. Choose screen jump function, the screen will jump to No.20 screen.

Place function key F4, press  key. Place it in the proper position. In its property box, choose the key value as F4, set it concealed. Choose screen jump function, the screen will jump to the alarm list..

Finish editing the bar curve screen.

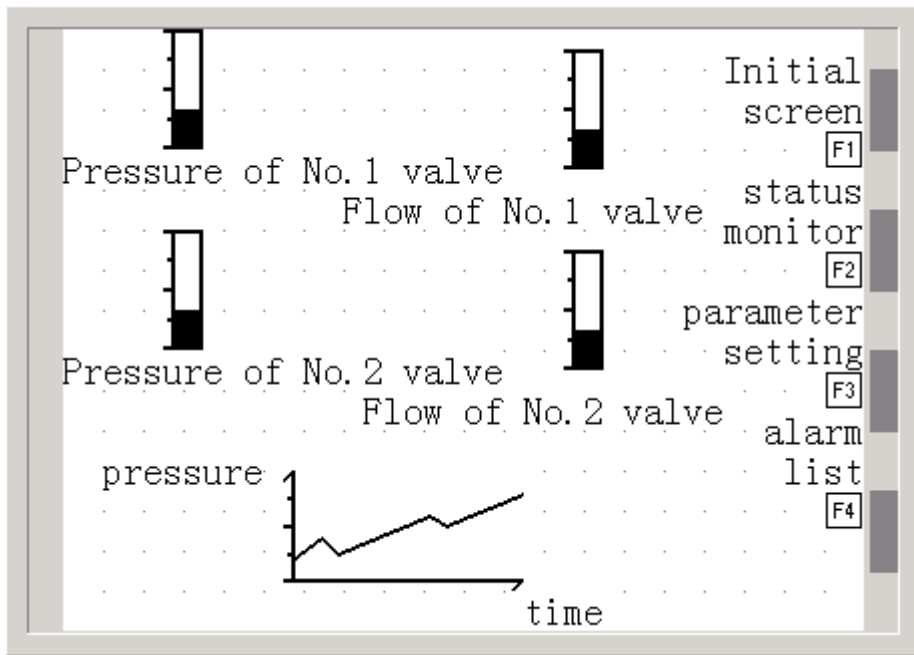

After finish editing the project, click  button to save it.

Connect the download cable, press download button to download the screen to OP520.

---

## **Chapter 6 OP320-S, OP320-A**

In this book, we will not tell the operation and application examples of OP320-S, OP320-A, OP320-A-S in details.

### **OP320-S**

For the size and use methods of OP320-S, you can refer to OP320.

You can referent OP320 about the size and usage of OP320-S. The difference between OP320-S and OP320 is the definition of the communication port

The usage of OP320-S is the same to OP320.

### **OP320-A/OP320-A-S**

OP320-A/OP320-A-S is a shrink version of OP520, you can refer to OP520 for its usage, but in function there is no global set function key, you can refer to OP320 for its use methods, and refer to OP520 for its number keys' usage.

---

## Chapter 7 PLC's connection method

### 7-1 xinje FC series PLC

OP series can communicate with xinje FC series PLC, the communication port is the PLC's program port.

Item	Content
OP320 communication port	9 pin communication port
PLC communication port	Program port
The default communication parameter	9600 bps, 8 bit, 1 stop, ODD
ID	1
Communication distance (the farthest)	15 m
Communication format	RS232
The type of the cable	OP-FC-CAB0
The corresponding addresses of the switch value	M0-M383
The corresponding addresses of the digital value	W0-W2047, FW0-FW191, TW0-TW127, CW0-CW127, WX0-WX13, WY0-WY13, WM0-WM23

The connection graph of OP-FC-CAB0

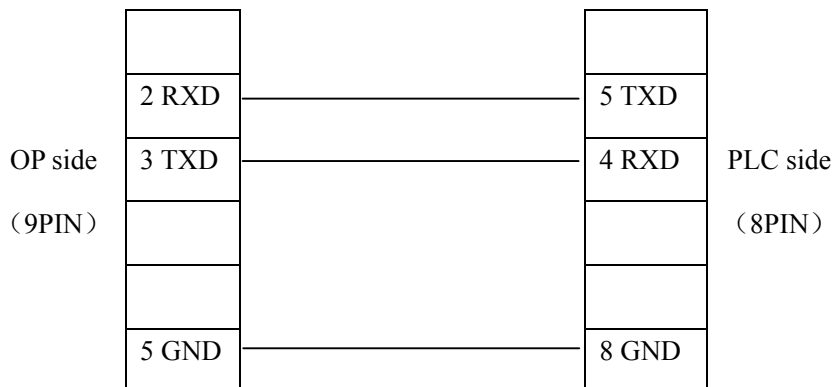

Note: it is proper for all OP series models

## 7-2 Mitsubishi FX series PLC

OP series can communicate with all FX series of Mitsubishi at present. The communication port is PLC program port or FX2N-422BD module of FX2N series PLC.

Item	Content		
OP320 communication port	9 pin communication port		
PLC communication port	Program port or FX2N-422BD		
The default communication parameter	9600bps, 7bit, 1 stop, Even		
ID	0		
Communication distance ( the farthest)	70 m		
Communication format	RS422		
The type of cable	OP-FX-CAB0		
	FX0S	FX0N	FX2N
The corresponding addresses of the switch value	M000-M511	M000-M511	M000-M511
The corresponding addresses of the digital value	D00-D31	D000-D255	D000-D511

The connection graph of OP-FX-CAB0

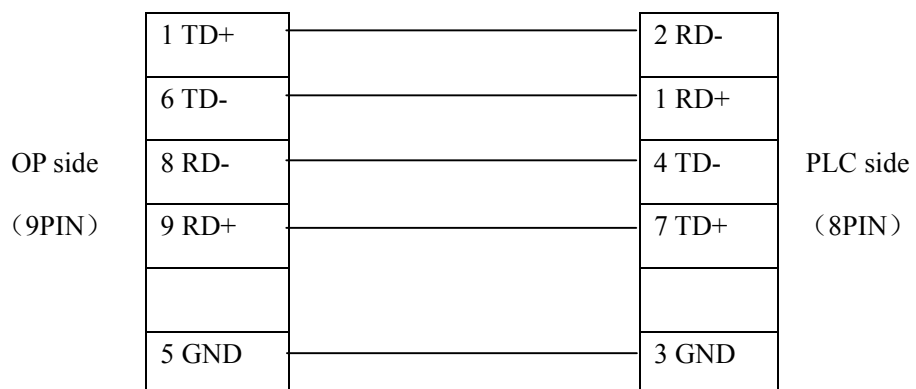

Note: it is proper for OP320, OP320-A, OP520.

## 7-3 Siemens S7-200 series PLC

OP series can directly communicate with program port or extension port of S7-200 series PLC via PPI protocol.

Item	Content
OP320 communication port	RS485 communication port
PLC communication port	Programming port or expansion port
The default communication parameter	9600 bps, 8 bit, 1 stop, Even
ID	2
Communication distance (the farthest)	100 m (twisted-pair)
Communication format	RS485
The type of the cable	OP-S7-CAB0
The corresponding addresses of the switch value	M000-M317
The corresponding addresses of the digital value	VW000-VW4096

The connection graph of OP-S7-CAB0

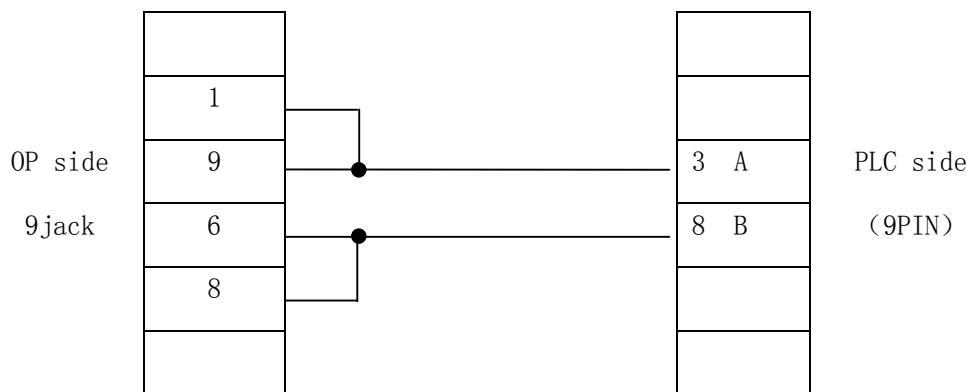

Note: it is proper for OP320-S, OP320-A-S, OP520.



## 7-4 Omron C series PLC

CPM1A, CQM1-CPU11 has only one communication port. In order to communicate with OP320, it needs the communication cable CIF01-CAB produced by our company to transfer the program port's signal to RS232 signal.

Item	Content
OP320 communication port	9 pin communication terminal
PLC communication port	Program port or expansion port
The default communication parameter	9600 bps, 87bit, 2 stop, Even
ID	0
Communication distance (the farthest)	15 m
Communication format	RS232
The type of the cable	OP-CQM-CAB0 or CIF01-CAB0
The corresponding addresses of the switch value	IR20000-22715
The corresponding addresses of the digital value	DM0000-DM1024

The connection graph of OP-CQM-CAB0

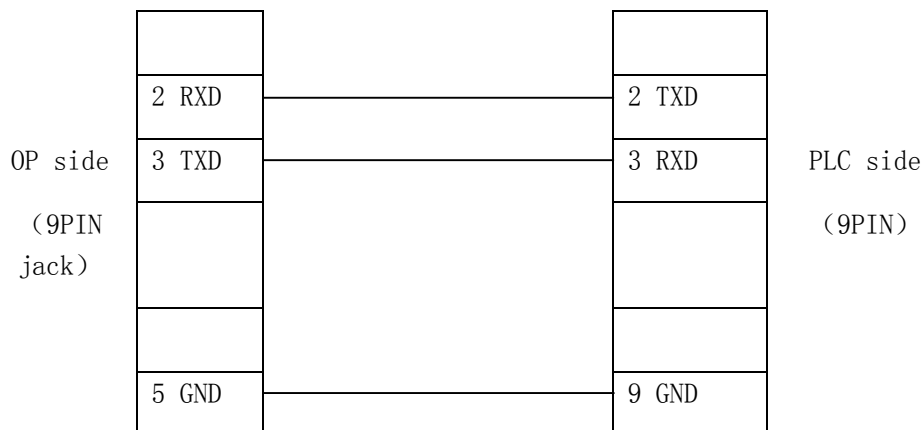

Note: it is proper for all OP series models.

## 7-5 Koyo S series PLC

When OP series is communicating with SZ-4, OP320 can connect with not only Port1 but also Port2.

Item	Content
OP320 communication port	9 pin communication port
PLC communication port	Program port or extension port
The default communication parameter	9600 bps, 8 bit, 1 stop, ODD
ID	1
Communication distance (the farthest)	15 m
Communication format	RS232
The type of the cable	OP-SZ-CAB0 corresponds with SZ, SH, SH series OP-SG-CAB0 corresponds with SU, SG series
The corresponding addresses of the switch value	M000-M377
The corresponding addresses of the digital value	R2000-R3777

The connection graph of OP-SZ-CAB0

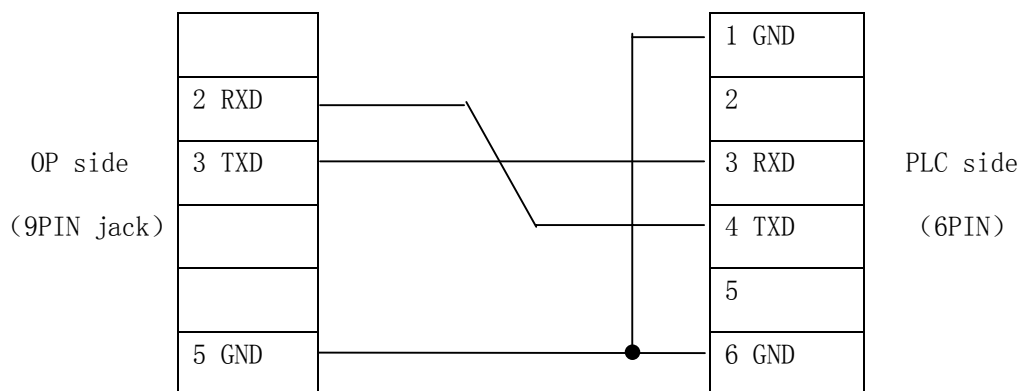

The connection graph of OP-SU-CAB0

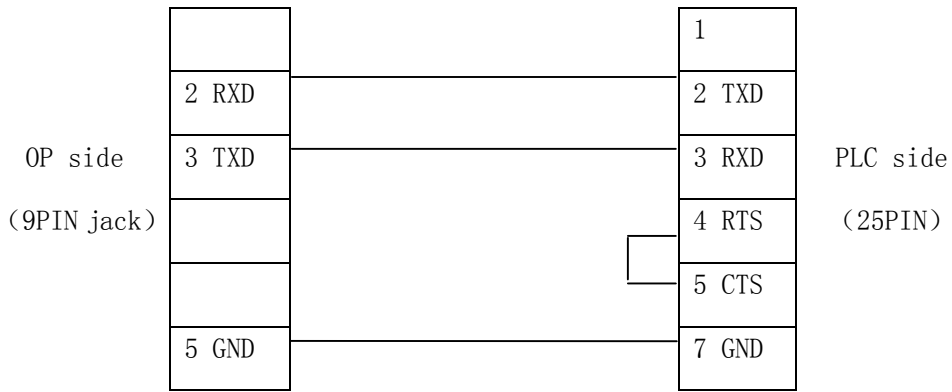

Note: it is proper for all OP series models.

## 7-6 Schneider NEZA series PLC

OP series can directly communicate with the NEZA series PLC via MODBUS protocol.

Item	Content
OP320 communication port	RS485 communication port
PLC communication port	Program port
The default communication parameter	9600 bps, 8 bit, 1 stop, Even
ID	1
Communication distance (the farthest)	100 m

farthest)	
Communication format	RS485
The type of the cable	OP-NEZA-CAB0
The corresponding addresses of the switch value	%M000-%M127
The corresponding addresses of the digital value	%MW000-%MW511

The connection graph of OP-NEZA-CAB0

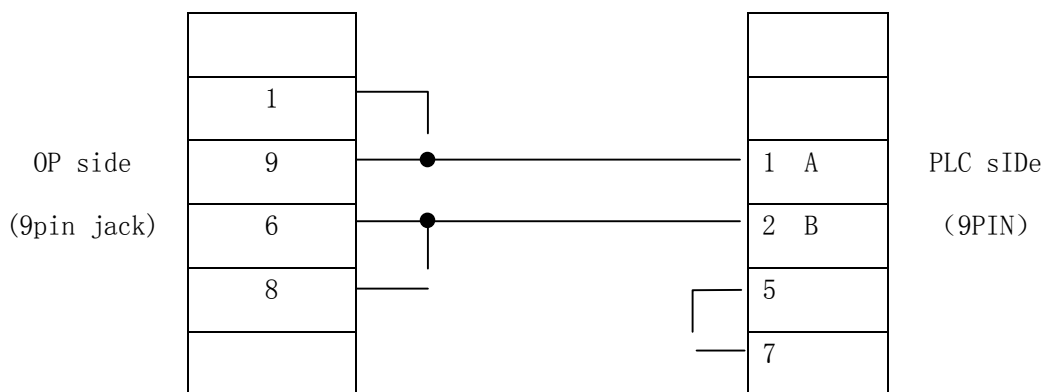

Note: it is proper for OP320-S, OP320-A-S, OP520.

## 7-7 DELTA DVP series PLC

OP series can communicate with DVP series PLC, the communication port is PLC program port.

Item	Content
OP320 communication port	9 pin communication port
PLC communication port	Program port
The default communication parameter	9600 bps, 8 bit, 1 stop, Even
ID	1
Communication distance (the farthest)	15 m

Communication format	RS232
The type of the cable	OP-DVP-CAB0
The corresponding addresses of the switch value	M0-M999
The corresponding addresses of the digital value	D0-D599

The connection graph of OP-DVP-CAB0

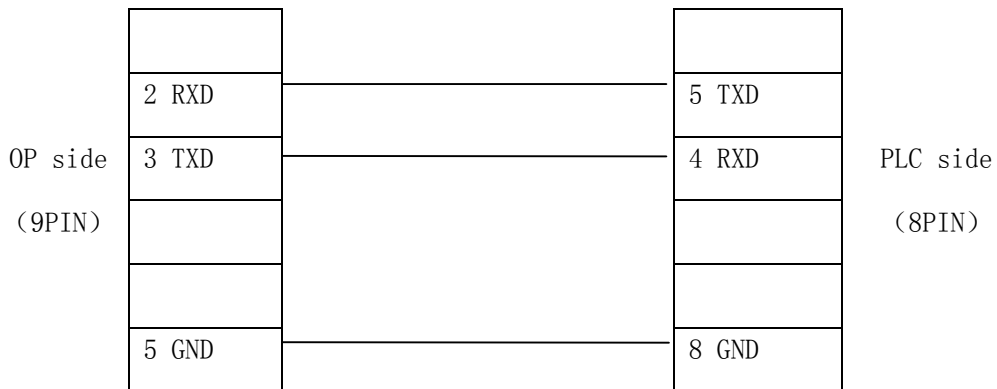

Note: it is proper for all OP series models.

## 7-8 LG Master-K series PLC

OP series can communicate with LG Master-K series PLC, the communication port is port 2.

Item	Content
OP320 communication port	9 pin communication port
PLC communication port	Port2
The default communication parameter	9600 bps, 8 bit, 1 stop, Even
ID	1
Protocol	Modbus Slave ( RTU ( HEX ) )
Communication distance (the farthest)	15 m
Communication format	RS232

The type of the cable	OP-LG-CAB0
The corresponding addresses of the switch value	M000-M191F
The corresponding addresses of the digital value	D0000-D4500

The connection graph of OP-LG-CAB0

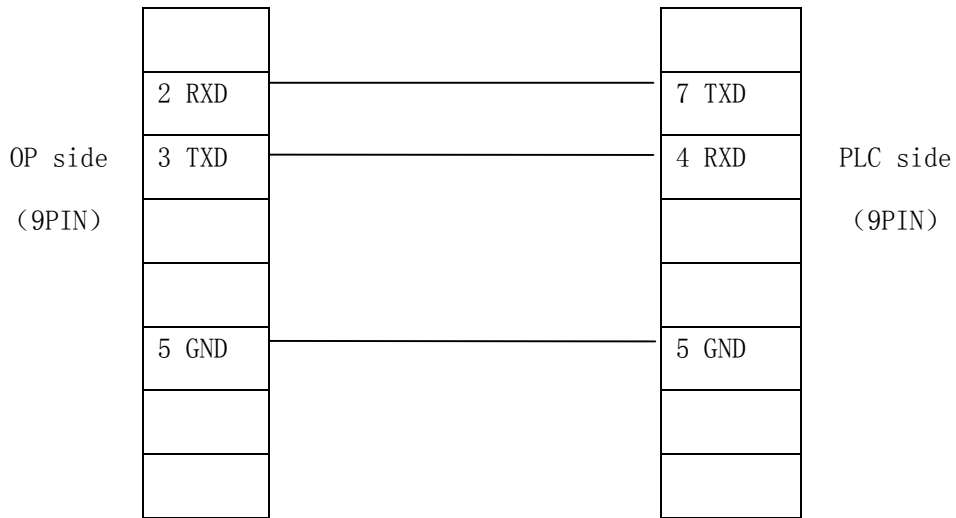

Note: it is proper for all OP series product.

## 7-9 Matsushita FP series PLC

OP320 can communicate with Matsushita FP series PLC, the communication port is PLC program port or extension port.

Item	Content
OP320 communication port	9 pin communication port
PLC communication port	Program port or extension port
The default communication parameter	9600 bps, 8 bit, 1 stop, ODD
ID	1
Communication distance (the farthest)	15 m
Communication format	RS232

The type of the cable	OP-FP1-CAB0
The corresponding addresses of the switch value	R0000-R875F
The corresponding addresses of the digital value	DT0000-DT9999

The connection graph of OP-FP1-CAB0

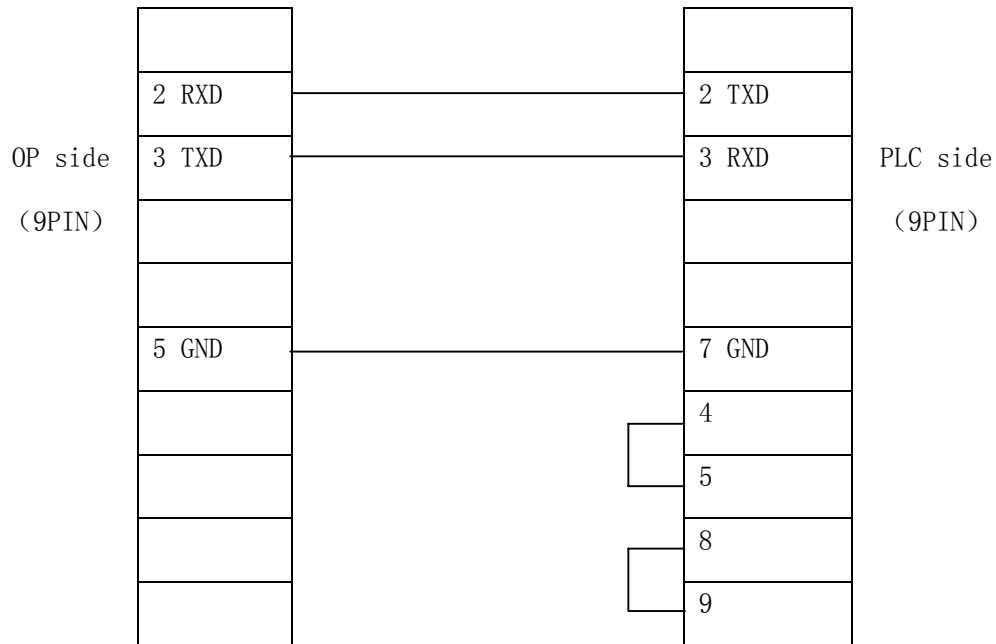

Note: it is proper for all OP series models

## 7-10 FACON FB series PLC

OP320 can communicate with FACON FB series PLC, the communication port is PLC program port or extension port.

Item	Content
OP320 communication port	9 pin communication port
PLC communication port	Program port or extension port
The default communication parameter	9600 bps, 8 bit, 1 stop, Even
ID	1
Communication distance (the feet)	15 m

farthest)	
Communication format	RS232
The type of the cable	OP-FB-CAB0
The corresponding addresses of the switch value	M0000-M1911
The corresponding addresses of the digital value	R0000-R8071

The connection graph of OP-FB-CAB0

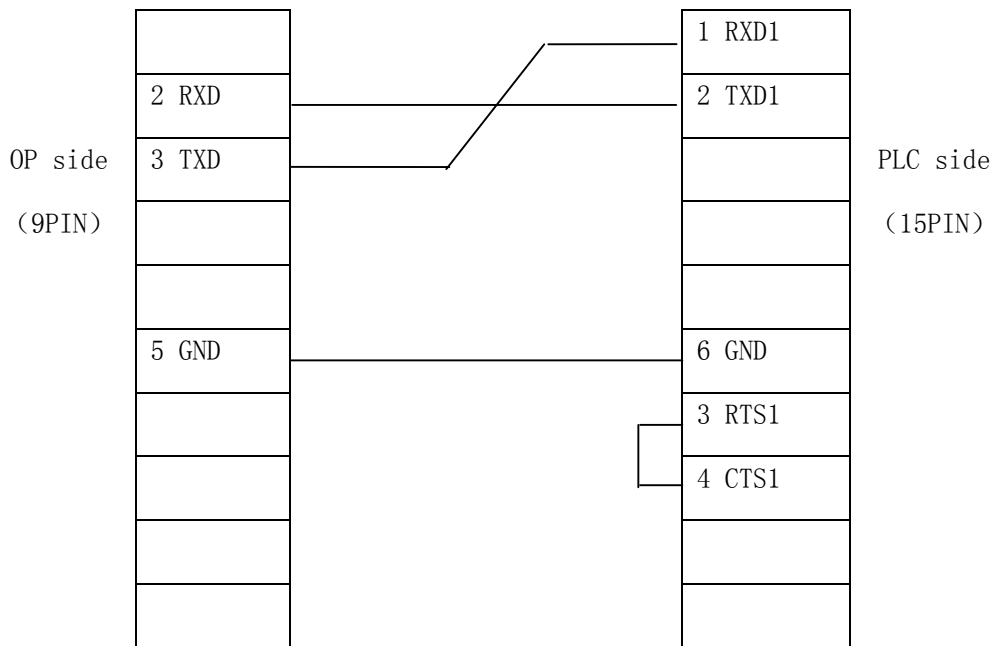



---

Note: it is proper for all OP series models

## 7-11 Kenyence series PLC

OP series can communicate with Kenyence series PLC, the communication port is the program port.

Item	Content
OP320 communication port	9 pin communication port
PLC communication port	Program port
The default communication parameter	9600 bps, 8 bit, 1 stop, ODD
ID	0
Communication distance (the farthest)	15 m
Communication format	RS232

The type of the cable	OP-KZ-CAB0
The corresponding addresses of the switch value	M0-M9240
The corresponding addresses of the digital value	D0-D9255

The connection graph of OP-KZ-CAB0

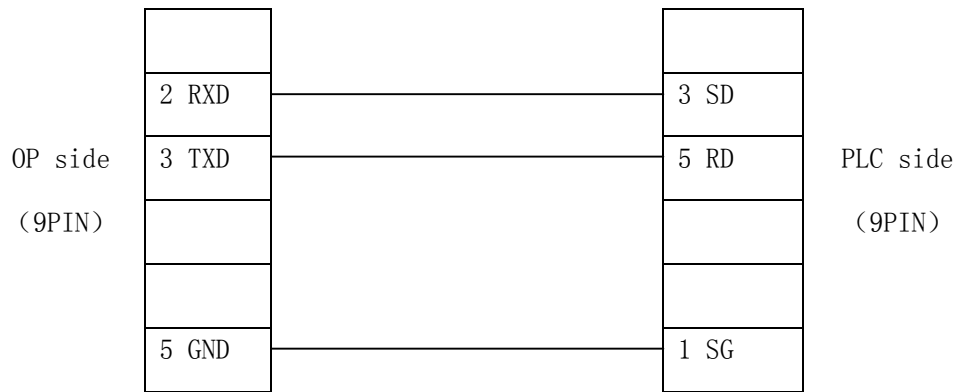

Note: it is proper for all OP series models